

FIRKÁK IV.

Fiatal Római Koros Kutatók
IV. Konferenciakötete

Proceedings of the 4th Conference
for Young Researchers of Roman Age



DISSERTATIONES ARCHAEOLOGICAE
ex Instituto Archaeologico
Universitatis de Rolando Eötvös nominatae
Supplementum 1.

FIRKÁK IV.

Fiatal Római Koros Kutatók IV. Konferenciakötete

Proceedings of the Conference for Young Researchers
of Roman Age

Pécs, 26.11.2010 – 28.11.2010

Visegrád, 10.11.2011 – 11.11.2011

edited by

Dávid BARTUS and Katalin BORUZS



Budapest – Visegrád 2018

Dissertationes Archaeologicae ex Instituto Archaeologico
Universitatis de Rolando Eötvös nominatae
Supplementum 1.

Editors:
DÁVID BARTUS
KATALIN BORUZS

Available online at <http://dissarch.elte.hu>
Contact: dissarch@btk.elte.hu



ISSN 2064-4574

© Eötvös Loránd University, Institute of Archaeological Sciences

© King Mathias Museum, Visegrád

Budapest – Visegrád 2018

CONTENTS

Előszó – Foreword	7
Papers presented at the conferences	8
Krisztina HOPPÁL	11
<i>Minden út Kínába vezet? Avagy a Római Birodalommal kapcsolatba hozható régészeti leletek problematikája</i>	
Cecília GÁBLI	33
<i>Plinius a gemmákról</i>	
István Gergő FARKAS	55
<i>Nomen provinciae. A principátus kori Raetia-Vindelicia kérdéskör megoldása</i>	
Ildikó TALABÉR	81
<i>Római kori gyűrűk a Janus Pannonius Múzeum régészeti gyűjteményéből</i>	
Nándor AGÓCS – István Gergő FARKAS	113
<i>A fragmented plate with a Latin inscription from Bakonya (Baranya county, Hungary)</i>	
Anita POLGÁR-NYERGES	117
<i>New researches carried out in the Járdányi-Paulovics István Ruin Garden in Szombathely. The stone ornaments of the governor's palace from Savaria</i>	
Máté SZABÓ – Dávid BERKECZ – Gábor BERTÓK – Csilla GÁTI – László LENKEY – Ottó OELBERG – Mihály PETHE – Máté STIBRÁNYI – Vera SZABÓ	137
<i>Geophysical investigations of Roman rural sites in the vicinity of Pécs (Baranya County, Hungary)</i>	
Katalin OTTOMÁNYI	159
<i>Late Roman Grave Groups in the Páty Cemetery</i>	
Katalin BORUZS – Géza SZABÓ	197
<i>Late Roman Graves in Dombóvár</i>	

Márta DARÓCZI-SZABÓ – László BARTOSIEWICZ 243

Horse-dog burials from preventive excavations at Dombóvár TESCO

Péter GRÓF 257

Sándor Soproni, Researcher of the Roman era of Visegrád

Pál PATAY 265

Castra Bonaventura

Előszó – Foreword

Idén immár 12. alkalommal került megrendezésre a Fialat Római Koros Kutatók Konferenciája, de az elhangzott előadások írott (hagyományos, papír alapú) formában történő megjelenése még sok esetben várat magára. Az első, 2006-ban tartott konferencia óta, melynek előadásai könyv formában már 2007-ben megjelentek, az utóbbi időben az aktuális konferencia és a kéziratok nyomdába kerülése között igen hosszú idő telt el. Ez több szempontból is hátrányos: egyrészt elmarad az új kutatási eredmények közzététele, amik a technika gyors fejlődésének köszönhetően gyakran már 1–2 év távlatából is elavultnak, túlhaladottnak számítanak. Másrészt csökkenhet a publikálási kedv, ami a konferencián elhangzottak szűk körben maradását vonja maga után, esetleg színvonalcsökkenést is.

A 2006-ban indult kezdeményezés, miszerint a római korról foglalkozó, kezdő kutatóknak is szükségük van saját fórumra, bebizonyította, hogy életképes. Az elnöki tisztséget betöltő egyetemi oktatók, elismert szakemberek biztosítják a rendezvények színvonalát, a „fiatalok” gyakorlatot szereznek az előadások készítése és prezentálása valamint a publikálás terén is. Éppen ezért is kifogásolható, hogy az elhangzottak nem „napra készen” jelennek meg. Ezt a „hibát” igyekszünk most kiköszörölni: jelen kötet nyomdába kerülésével a FIROKONF-on elhangzottak 2012-ig terjedően (az I–VII. konferenciáig) nyomtatott verzióban is elérhetőek. Célunk kivitelezéséhez hozzájárultak azok a kutatók, akik ennyi év eltelte után is bíztak a pozitív végkifejletben és rendelkezésünkre bocsátották kézírataikat.

Reméljük, hogy a 2014 óta tartott konferenciák szervezői is optimistán állnak a manapság mostohagyerekként kezelt könyvkiadáshoz és minél hamarabb megtalálják a módját a publikációk megjelentetésének.

A FiRKÁK IV. kötete két rendezvény eddig nem publikált tanulmányait adja közre, emellett színesíti egy korábbi konferenciakötetből kimaradt kézirat, valamint Patay Pál Soproni Sándorra emlékező rövid írása, amivel Visegrád római korának jeles kutatója előtt szeretnénk tisztelegni.

Visegrád, 2018 áprilisában

Boruzs Katalin

Papers presented at the conferences

5th Conference for Young Researchers of Roman Age

26.11.2010–28.11.2010

Organizer: University of Pécs, Faculty of Humanities

Venue: Pécsi Kulturális Központ, Dominikánus Ház

HOPPÁL Krisztina: Minden út Kínába vezet? Avagy a Római Birodalommal kapcsolatba hozható régészeti leletek problematikája

GÁBLI Cecília: Plinius a gemmákról

TÓTH István Zsolt: Beszámoló a Pécs Janus Pannonius u. 10. (Rózsakert) területén végzett 2010. évi régészeti kutatásokról

BORHY László – SZÁMADÓ Emese – DÉVAI Kata – BÓZSA Anikó: Brigetio polgárvárosának II. számú temetője (Komárom, Mártírok útja, Lidl)

SZABÓ Ernő: A collegiumok temetkezési hozzájárulása Pannoniában

NAGY Levente: Római lelőhelyek védetté nyilvánítása 2001 és 2009 között

LASSÁNYI Gábor: Pannonia kifosztása

WILHELM Gábor – SÓSKÚTI Kornél: A Kiskundorozsma-Nagyszék lelőhelyen előkerült szarmata települések (2-5. század) római készítésű kerámiaanyaga

VÁMOS Péter: Észak-afrikai applikált díszű edények Aquincumban

H. HARSÁNYI Eszter: Fehér a feketén – avagy hogyan kerül az ige a pohárra?

SZABÓ Ádám: Silvanus a sötét Pan

BÍRÓ Szilvia: Földbe mélyített házak Pannoniában önálló településtípus vagy helyi jellegzetesség?

CSAPLÁROS Andrea – Neuhauser Tina: „Határok nélküli kultúra Noricum és Pannonia között”

CSIKI József Attila: Környe község topográfiája archív légifotók alapján

FEHÉR Bence: Germanus, Respectus, Adiutor és a többi

AGÓCS Nándor: Augustalis testületek a Duna-vidéki tartományokban

SZABÓ András: Auxiliaris centuriok és decuriok

FARKAS István Gergő: Újabb adatok a pannoniai auxiliaris csapatok titulaturájának vizsgálatához

VARGA Gábor: A Szentendrei-sziget római kori erődítetttsége

SZABÓ Máté – PÁNCZÉL Szilamér: Rómaiak a Székelyföldön

FAZEKAS Ferenc – SZABÓ Antal: Újabb régészeti kutatások Lussoniumban (2009-2010)

BARTUS Dávid: Bronzszobrok Brigetióból

JUHÁSZ Lajos: Egy újabb germán kisbronz Brigetioból

MERCZI Mónika: Újabb sírok a nyergesújfalui tábor késő római temetőjéből

HULLÁM Dénes: Római tárgyak a Kárpát-medencei Barbaricum északkeleti részéről

6th Conference for Young Researchers of Roman Age

10.11.2011–11.11.2011

Organizer: King Mathias Museum of Hungarian National Museum

Venue: Visegrád, Királyi Palota lovagterme

BUZÁS Gergely: Római kövek a középkorban

GRÓF Péter: A római limes visegrádi emlékei és a Dunai Limes – UNESCO Világörökség program

TÓTH János Attila: Rómaiak a Dunában

SZABÓ Antal – FAZEKAS Ferenc: A lussoniumi régészeti kutatások újabb eredményei (2011)

TOKAI Zita Mária: Kora császárkori temető Alsópáhok – Hévízdombon

MERCZI Mónika: Újabb késő római sírok az Esztergom-Kossuth Lajos utcai temetőből

OTTOMÁNYI Katalin: Késő római sírcsoportok Pátyon

LASSÁNYI Gábor: Temető a Duna partján - Kutatások az aquincumi polgárváros keleti nekropoliszában

KISS Péter – POLGÁR-NYERGES Anita: „A szombathelyi Járdányi Paulovics István Romkert újabb kutatásai”

HÓDI Attila: Adatok a savariai Isis-szentély építéstörténetéhez

BALÁZS Péter: A savariai Iseum kútja

SOSZTARITS Ottó – A savariai Iseum

TÍMÁR Lőrinc: Térszervezés a római lakóházépítészetben

HORTI Gábor: A Római Birodalom határvédelmének mélységi tagozódása, kérdések és problémák

SZABÓ Máté: Nem romboló régészeti módszerek alkalmazása a pannoniai villakutatásban

EKE István: Késő római villa Badacsonyan

PÁNCZÉL Szilamér: Üvegtárgyak tanúsága egy színházból

RUPNIK László: Sírköveken ábrázolt szerszámok Pannoniából

SÓSKUTI Kornél – WILHELM Gábor: Római leletanyag a Felgyő–Kettőshalmi-dűlőben feltárt szarmata településen

PROHÁSZKA Péter: A Vérteskethelyi 4. századi éremlelet: lehetőségek a rekonstrukcióra

TORBÁGYI Melinda: Pénzforgalmi kutatások a római kori Magyarországon

Late Roman Graves in Dombóvár

KATALIN BORUZZS

*Hungarian National Museum
Mátyás Király Museum, Visegrád*
boruzskatalin@visegradmuzeum.hu

GÉZA SZABÓ

*Wosinsky Mór Museum
Szekszárd*
kaladeaa@gmail.com

Abstract

There have been data about Late Roman graves or objects supposedly deriving from such graves in the area of Dombóvár since the end of the 19th c. However, the opportunity to document such finds found in a large territory only opened up in 2007, in the excavation prior to the construction of the Tesco building. In our present article we have undertaken the task to introduce altogether 23 graves including the ones discovered some years later in the area of the Public cemetery in Újdombóvár. The types of the grave furniture and their execution are similar to the finds in the cemeteries in Southern-Transdanubia, which can be dated at the second half of the 4th c. The jewels, clothes trimmings, coins for the last journey, vessels for food and drink, perhaps the necessities for everyday life, were placed in the grave beside the dead. Two girls' graves can be considered the richest of the earth graves, besides money the deceased aged 9-17 had 11 grave goods – mainly jewels. A brick-walled grave and a nearby horse-dog burial place are also special, they refer to the distinguished status of the deceased. We consider that the graves described below were the family burial places of small, Late Roman settlements grown in the vicinity of the present town.

Introduction

The first records of the archaeological features and finds in Dombóvár go back to Flóris Rómer¹ and Mór Wosinsky². There have been data about Late Roman graves or objects supposedly deriving from such graves in the territory of Dombóvár since the end of the 19th c. – since the clay-fields of the brick factories were opened and since the road and railway building began. Unfortunately, the exact place and description of the finds have not always survived because of the contemporary collecting customs. The collection of several data and objects is thanks to the rescue excavations in the 1960s and 70s as well as to the establishers of the local archaeological collections. They have provided the information that – among others – in 1926 a brick-lined grave with a fish incised in one of the bricks was found on the playground in Kölcsey utca, in 1968 in clay-field of the Brick factory I then in 1970 in VII. utca as well the remains of brick-lined graves were found.³ Late Roman graves in a larger territory were disclosed in the excavation prior to the construction of the Tesco building in the north-western part of the area. Three years later, in 2010, when in the territory of the Újdombóvár public cemetery a canal was being dug, a small glazed jar was found, which indicated that there was a burial site as well. In our present article we have undertaken the task to introduce altogether 23 graves (*Fig. 1*).

1 SZABÓ 2010, 53. The present paper was translated by Erika Zoltán.

2 WOSINSKY 1896, II. 752-753.

3 ALBEKER 1978; SZŐKE 1996, 29.

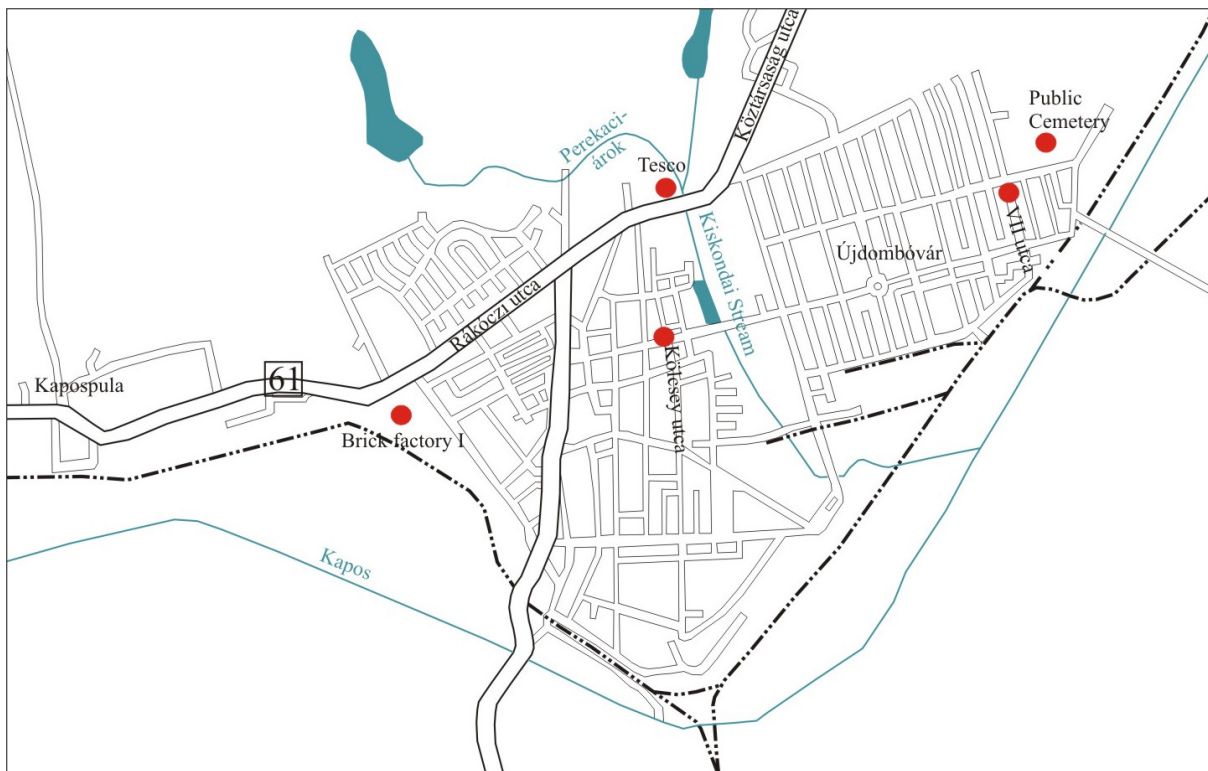

Fig. 1. Roman graves in Dombóvár.

Dombóvár – Tesco

On the right bank of the Kiskondai Stream, fragments of pottery and bones came to light during levelling for the supermarket to be built, to which Imre Bodó, local historian, called the attention of the museum in Szekszárd. After this, settlements and their cemeteries of several periods were disclosed on 18.000 m² in six weeks during the rescue excavation parallel with the construction.⁴ Out of 528 finds 22 may have originated in the Late Roman Age, most of them were simple earth graves. In one of them, the skeletons of a horse and a dog were found, nearby there was a brick grave with another person later buried among its tampered roof tiles. From the position of this part of the cemetery and the type of terrain it can be concluded that the cemetery may have continued into the north-westward direction. Presumably some graves were destroyed because of soil erosion and during earlier earthwork in the presently excavated area as well.⁵ No other finds or relics (e.g. sporadic coins, terra sigillata) from the Roman times have come to light besides the graves in the area, as nothing was found in the initial excavations on the eastern side of the Kiskondai Stream in 2009 (Fig. 2).⁶

4 More about the site: SZABÓ 2007; BORUZS – SZABÓ 2009a.

5 The description may refer to this site, in which Gyula Rosner wrote about brick graves in Túskepuszta, classifying them to the area of brick factory II (WMM Rég. Ad. 96-73).

6 BORUZS – SZABÓ 2009b.



Fig. 2. Excavated Tesco area with Roman graves.

Description of graves and objects⁷

Q39 (Plate I)

Regular rectangular shaped cist grave with vertical walls and a flat bottom (200x70, 120), with the skeleton of a 60-75-year-old woman⁸ with her head at the eastern end. The upper part of the skeleton is destroyed: the skull is below the left shoulder, at the humerus. The spine is particularly curved at the thoracic vertebrae. The left forearm rested near the left pelvis on the thigh and the right forearm was placed on the chest. The legs were stretched, the feet tilted outwards.

J1 Bronze coin (2008.3.39.4) – Urbs Roma, AE3. H: wolf suckling twins with 2 stars above. Siscia, 334-335. ΔSIS-. RIC 240.⁹ **J2 Bronze coin** (2008.3.39.3) – Constantinopolis, AE3. H: Victoria. Thessalonica 330-3, 336-7. SMTSE. RIC 188, 230. **J3 Bronze coin** (2008.3.39.5) – Constantius II, AE3. H: GLORIA EXERCITVS, 2 signums. Antiochia 330-3, 335. SMANZ. RIC 88. **J4 Iron rod** (2008.3.39.10) – Round in cross section, solid, one end is pointed. 21.8x0.8.

7 Abbreviations: Q = archaeological feature, J = find. The size of graves: length x width, depth measured after the removal of topsoil, the size of vessels: height, diameters of the mouth and base in cm.

8 The anthropological estimates were given by Tamás Hajdu and Ildikó Pap, grateful thanks are due for their work.

9 Melinda Torbágyi identified the coins. We are thankful that she has ceded the right of the publication of her results.

J5 Bowl (2008.3.39.8) – Cone-frustum-shaped with a slightly incurved, ringed rim. Its surface is burned brown. 4, 17.2, 11.6. **J6 Iron knife** (2008.3.39.6) – Humpbacked, its handle joins the blade in the middle, broken. 9.2x2.7. **J7 Bronze bracelet** (2008.3.39.1) – Twisted of 3 bronze threads with a hooked-looped clasp. 5.7x6.7x0.4. **J8 Glass** (2008.3.39.9) – Light green, transparent, made of bubbly material, conic with evenly thin wall. Its rim slightly curves outwards, is cut straight, polished. Its bottom is even. Unadorned. 9.8, 7.4, 2.6. **J9 Bronze bracelet** (2008.3.39.2) – Made of round-cross sectioned wire, open with flattened tips. Grooved at one end. Slightly deformed. 5.2x6.2x0.2.

Q40 (*Plate II*)

Big, rectangular grave (220x170, 100). The fragments of wood structure along the walls refer either to the possibility that the grave was either timbered or the deceased was buried in a large wooden coffin together with the grave goods. The grave contained the skeleton of a 30-50-year-old man(?) with the head at the eastern end. The thoracic bones, the right forearm and the pelvis completely disintegrated. His left forearm was placed on his stomach. The skull was found completely crushed and squashed, so was the pottery.

J1 Bronze fibula (2008.3.40.29) – Big bulbs ending in tips, one of the tips broke down. Its bow is decorated with diagonal grooving between two chased, beautifully curved lines along it. Its catch-plate is trapezoid with chased points, 1 pair on its part near the bow and 2 pairs on its end. In the middle of the catch-plate there are two parallel chased lines. Its pin has not been found, it may have been made of iron. 8.2x4.6x2.8. **J2 Bronze coin** (2008.3.40.20) – Constantius II, AE3. H: FEL TEMP REPARATIO, rider. 355-361, M /, ? **J3 3 Bronze coins** (2008.3.40.2) – Constantius II AE3. H: FEL TEMP REPARATIO, rider. Siscia 351-355, E.: A /, H.: I /, BSIS-S. RIC 346. (2008.3.40.3) – Constantius II, AE3. H: FEL TEMP REPARATIO, rider. Siscia 351-361, ΔSIS[. (2008.3.40.4) – Constantius II, AE3. H: FEL TEMP REPARATIO, rider. 351-361, ·S /, ? **J4 14 Bronze coins** (2008.3.40.5) – Constantius Gallus AE2. H: FEL TEMP REPARATIO, rider. Siscia 351-354, E.: A /, H.: I /, ASIS-S. RIC 347. (2008.3.40.6) – Constantius II, AE3. H: FEL TEMP REPARATIO, rider. Siscia 351-361, BSISz. RIC 352, 361. (2008.3.40.7) – Constantius II, AE3. H: FEL TEMP REPARATIO, rider. 351-361. (2008.3.40.8) – Constantius II, AE3. H: FEL TEMP REPARATIO, rider. Siscia 351-361, ASISZ. RIC 352, 361. (2008.3.40.9) – Constantius II, AE2. H: FEL TEMP REPARATIO, rider. Thessalonica 350-355, S /, TSA. RIC 185. (2008.3.40.10) – Constantius II, AE3. H: FEL TEMP REPARATIO, rider. Cyzicus 351-354, E.:E /, H.: SMKB. RIC 100. (2008.3.40.11) – Constantius II, AE3. H: FEL TEMP REPARATIO, rider. Siscia 351-361, ΓSI[. (2008.3.40.12) – Constantius II, AE3. H: FEL TEMP REPARATIO, rider. Thessalonica 350-355, E /, (sm)TS. RIC 189. (2008.3.40.13) – Constantius II, AE3. H: FEL TEMP REPARATIO, rider. Siscia 351-355, ΔSIS. RIC 350. (2008.3.40.14) – Julianus AE3. H: FEL TEMP REPARATIO, rider. Siscia 355-361, M /,]SIS[. cf. RIC 371, 374, etc. (2008.3.40.15) – Constantius II, AE3. H: FEL TEMP REPARATIO, rider. Sirmium 355-361, M /, BSIRM[. RIC 73, 77. (2008.3.40.16) – Constantius II, AE3. H: FEL TEMP REPARATIO, rider. Thessalonica 350-355, ? /, SMTS? RIC 189, 192. (2008.3.40.17) – Constantius II, AE3. H: FEL TEMP REPARATIO, rider. Siscia 355-361, M /, ΓSIS[. (2008.3.40.18) – Julianus, AE3. H: FEL TEMP REPARATIO, rider. Siscia 355-361, M /,]SIS, recoined. **J5 3 Bronze coins** (2008.3.40.21) – Constantius Gallus AE2. H: FEL TEMP REPARATIO, rider. 351-354. (2008.3.40.22) – Constantius Gallus AE2. H: FEL TEMP REPARATIO, rider. Constantinople, 351-354, ·S / *, CON[. RIC 117. (2008.3.40.23) – Constantius

II, AE3. H: FEL TEMP REPARATIO, rider. Nicomedia 351-361,? /, SMN[. **J6 Fragments of 3 three iron objects. Iron object** (2008.3.40.26) – Round in cross section, narrowing towards on end. Both ends are broken. 7.8x1.4. **Iron knife** (2008.3.40.27) - Fragment. Its handle joins the blade in the middle. 8x3.1. **Iron object** (2008.3.40.28) – Curved sided, pierced small iron fragment. 2.2x2. **J7 Bowl** (2008.3.40.24) – Its material is brick-red, with tawny glaze on the inside and rim. Deep bowl with a rim horizontally everting, curved side, narrow base. 7, 22.4, 7. **J8 Jar** (2008.3.40.25) – Its material is brick-red with greenish brown glaze on the outer side. Its cylindrical neck is stretched, spindle-shaped and narrow with the rim widening and everting. The unadorned strap handle is between the rim and the middle of the body. 28.5, 6.6, 7.2. **J9 Bowl** (2008.3.40.19) – Cone-frustum-shaped, with a slightly incurved, ringed rim. 4, 14.6, 10.4.

Q41 (Plate I)

Irregularly shaped grave (160x70, 25-30). In the grave the skeleton of a 5-6-year-old child was found with the head at the eastern end. The head is tilted to the right shoulder, the left forearm is placed on the stomach and the right arm is bent beside the right hip bone.

J1 Jar (2008.3.41.15) – The material tempered with sand is brick-red, well baked. The outside has greenish brown glazing. The vessel had a profiled rim, narrow mouth, long cylindrical neck, stretched spherical body and widening base. It may have had a handle but it broke down together with the rim, the jar was found in the grave without them. 19.8, 2.8, 6. **J2 Bowl** – (2008.3.41.1) Greyish brown cone-frustum-shaped bowl with an incurved rim, smoothed surface. 5.1, 17.2, 10.5. **J3 Bronze coin** (2008.3.41.2) – Valens AE3. H: SECVRITAS REIPVPLICAE. Siscia 367-375, *P / M,]SISC. RIC 15b/17. **J4 2 Bronze coins** (2008.3.41.3) – Valentinianus I, AE3. H: GLORIA ROMANORVM. Siscia 364-367, ·FSISC. RIC 5a/2. (2008.3.41.4) – Valentinianus I, AE3. H: SECVRITAS REIPVPLICAE. Siscia 367-375, D /, *ΔSISC. RIC 15a/11. **J5 8 Bronze coins** (2008.3.41.5) – Iovianus AE3. H: Vot/V/Mult/X. Siscia 363-364, BSIS. RIC 426. (2008.3.41.6) – Valentinianus I, AE3. H: SECVRITAS REIPVPLICAE. Siscia 367-375, R /, ·ASISC. RIC 15a/10. (2008.3.41.7) – Valens AE3. H: SECVRITAS REIPVPLICAE. Siscia 364-367,]SISC. RIC 7b/1-4. (2008.3.41.8) – Valens AE3. H: SECVRITAS REIPVPLICAE. Siscia 367-375, R /, ·BSISC. RIC 15b/10. (2008.3.41.9) – Valens AE3. H: GLORIA ROMANORVM. Siscia 367-375, / R, ·BSISC. RIC 14b/10. (2008.3.41.10) – Valens AE3. H: GLORIA ROMANORVM. Siscia 364-367, / A*, DBSISC. RIC 5b/7. (2008.3.41.11) – Valens AE3. H: RESTITVTOR REIP. Thessalonica 364-367, TESΔ. RIC 17b/3. (2008.3.41.12) – Valentinianus I, AE3. H: GLORIA ROMANORVM. Siscia 367-375, / D,]SISC. RIC 14a/11-12. **J6 Bronze coin** (2008.3.41.13) – Constantius II, AE4. H: SECVRITAS REIPVPLICAE. 355-361. **J7 Bronze coin** (2008.3.41.14) – Valens AE3. H: SECVRITAS REIPVPLICAE. Siscia 364-367, *A /,]SISC. RIC 7b/5-7.

Q54 (Plate III)

The exact size and form of the grave is not known. The skeleton of a 45-60-year-old woman lay in it with the head at the eastern end. The skull tilted forward, the jaw fell on the cervical vertebrae, the left arm was on the sacrum, the right arm lay above it on the lower lumbar vertebrae. The legs were stretched, the feet tilted outwards. There were fragments of Celtic vessels in the earth of the grave.

J1 Earring (2008.3.54.1) – Oval ring made of thin bronze wire, with a hooked-looped clasp. 2.1x1.9x0.1 **J2 Earring** (2008.3.54.2) – Fragment of oval, thin bronze wire, with a hooked-looped

clasp. 1.8x1.6x0.1 **J3 Vessel** (2008.3.54.3) – Smoothed surface, with a small everted rim, rounded shouldered, wide base. At the half part of the body there is a fragment of the start of the handle. 13, 12, 7.2. **J4 Bronze coin** (2008.3.54.4) – Valens AE3. H: SECVRITAS REIPVBLICAE. 364-378.



Fig. 3. Detail of grave 56. Above the left wrist (8–9) coins put in a pouch(?) can be seen.

Q56 (Plate III, Fig. 3)

Rectangular grave with the end rounded (180x80, 100). In the grave the skeleton of a 9-11-year-old child was found with the head at the eastern end. The skull is tilted to the left. The left arm loosely placed beside the body, the hand where the femur and pelvis joined. The right forearm was put on the stomach. Legs stretched.

J1 Earring (2008.3.56.17) - Ring made of thin silver wire, with a hooked-looped clasp. 1.8x1.9x0.17. **J2 Earring** (2008.3.56.18) – Ring made of thin silver wire, with a hooked-looped clasp. 1.8x1.9x0.17. **J3 String of beads** (2008.3.56.24-25) – Necklace of prismatic or melon-shaped glass-paste beads, with a small clasp of bronze wire. (Unknown place.) **J4 Mount** (2008.3.56.30) – Round, concave-headed, short mount or ornamental nail decorated with a chased circle. 1.2x0.6. **J5 Bronze bracelet** (2008.3.56.19) – Regular ring-shaped open bracelet made of wire, round in cross section, its ends are flattened and chased. 4.8x5x0.23. **J6 Bronze bracelet** (2008.3.56.1) – Regular ring-shaped open bracelet made of wire, round in cross section, its ends are flattened and chased. 4.6x4.7, 0.2. **J7 2 Bronze coins** (2008.3.56.20) – Constantius II, AE3. H: FEL TEMP REPARATIO, rider. 351-361. (2008.3.56.21) – Constantius Gallus AE3. H: FEL TEMP REPARATIO, rider, 351-354. **J8 2 Bronze coins** (2008.3.56.28) – Constantius II, AE3. H: FEL TEMP REPARATIO, rider. Siscia, 351-361, ASISZ. RIC 352, 361. (2008.3.56.29) – Constantius II, AE4. H: SPES REIPVBLICAE, 355-361. Very worn, fragmented. **J9 13 Bronze coins** (2008.3.56.4) – Constantius II, AE2. H: FEL TEMP REPARATIO,

rider. 348-355. E.: A /, H.: ? (2008.3.56.5) – Constantius II, AE3. H: FEL TEMP REPARATIO, rider. Siscia 355-361, M /, (sis)R. (2008.3.56.6) – Iulianus AE3. H: FEL TEMP REPARATIO, rider. Siscia 355-361, M /,]SISD. RIC 374. (2008.3.56.7) – Iulianus AE3. H: FEL TEMP REPARATIO, rider. Siscia 355-361, ΔSISZ. RIC 363. (2008.3.56.8) – Constantius II, AE3. H: FEL TEMP REPARATIO, rider. Siscia 351-361,]SIS[(2008.3.56.9) – Constantius II, AE3. H H: FEL TEMP REPARATIO, rider. Siscia 355-361, M /, (si)SD. RIC 372. (2008.3.56.10) – Constantius II, AE4. H: SPES REIPUBLICAE. Siscia 355-361,]SIS. RIC 393. (2008.3.56.11) – Constantius II, AE3. H: FEL TEMP REPARATIO, rider. 355-361, M /, A[. (2008.3.56.12) – Julianus AE3. H: FEL TEMP REPARATIO, rider. Thessalonica 355-361, M /, SMTSA. RIC 210. (2008.3.56.13) – Constantius II, AE3. H: FEL TEMP REPARATIO, rider. Sirmium 355-361, M /, ·ASIRM. RIC 75. (2008.3.56.14) – Constans AE4. H: GLORIA EXERCITVS, 1 signum, 337-340. E: DN CONSTA-NS PF AVG. (2008.3.56.15) – Constantius II, AE3. H: FEL TEMP REPARATIO, rider. Sirmium 351-355, BSIRM. RIC 48. (2008.3.56.16) – Constans AE3. H: FEL TEMP REPARATIO, phoenix. Siscia 348-350,]SIS. RIC 232. **J10 Bronze bracelet** (2008.3.56.23) – Made of wide bronze sheet, closing with a clasp. Decoration: embossed berries, among them chased dots in three vertical rows, along the edges engraved lines. 5.8x5.8x0.8. **J11 Bone hairpin** (2008.3.56.2) – Spindle-shaped, decorated with woman's bust, unimpaired. The bust is grooved like a fir-cone, the face is damaged, its elaboration cannot be seen. The hairdo is represented with chased lines starting from the edge of the face and running to the sides and upwards, on the back the lines crossed. Lathed, carved. 9.4. **J12 Bowl** (2008.3.56.26) – Dark grey, glittering material, conical-frustum-shaped. Rounded rim, smoothed surface. 4, 14, 9. **J13 Iron rod** (2008.3.56.27) – Round in cross section, solid, one end is pointed. 22.4x0.8. **J14 The base of a glass vessel** (2008.3.56.3) – The fragment of the rather thick, rounded base of a dark green, translucent object made of bubbly material. 3.1x2.2. **J15 Bronze finger ring** (2008.3.56.22) – Made of thin wire grooved on the edges. The ends do not fit perfectly. 1.6x1.7x0.16.

Q57 (Plate IV, Fig. 4)

Rectangular, grave slightly narrowing downwards, with a flat bottom. (210x90, 15-25). In the grave was the skeleton of a 35-40-year-old woman with her head at the eastern end. The arms are bent: the left arm at a right angle with the hand on the right ribs. The right arm stretches above the stomach onto the right hip bone.

J1 Bronze bracelet (2008.3.57.3) – Twisted from 3 wires, widening in the middle, with hooked-looped clasp. The loop is broken, not found. At the loop end it is fastened with two clamps. 6.8x6.4, 0.7. **J2 Bronze bracelet** (2008.3.57.8) – Twisted from 4 wires, widening in the middle, with hooked-looped clasp. At the loop end it is broken, incomplete. 6.7x6.2, 0.4. **J3 Bronze bracelet** (2008.3.57.4) – Twisted from 4 wires, widening in the middle, with hooked-looped clasp. At the loop end it is broken, incomplete. 7x6.4, 0.7. **J4 Earring** (2008.3.57.6) – Ring-formed, made of thin bronze wire with a hooked-looped clasp. Slightly deformed. 1.6x1.7. **J4 Earring** (2008.3.57.7) – Ring-formed, made of thin bronze wire. It may have had a hooked-looped clasp. It has a conical pendant made of bronze sheet. 2.8x1.5. **J5 Iron rod** (2008.3.57.5) – Round in cross section, one end is pointed. 27x0.8. **J6 Poultry bones. J7 Mug** (2008.3.57.1) – Narrow based, compressed spherical form, with wide mouth and ringed rim. Grey with small burns in 2 places. With strap handle. 8, 8, 4. **J8 Bowl** (2008.3.57.2) – conical-frustum-shaped, with rounded rim. Its surface is rather worn, may have been smoothed. 4.8, 13.6, 8.2.



Fig. 4. Bracelets in grave 57.

Q58 (Plate IV)

Rectangular shaped grave (c 170x60, 100) with vertical walls and a flat bottom with the skeleton of a 60-70-year-old man with his head at the eastern end. The head fell towards the left shoulder, the feet are tilted outwards. The arms are bent at about a right angle, the left forearm is on the line of navel, the right forearm is placed on the stomach on the pelvis. Fragments of Celtic vessels and animal bones were found in the earth of the grave.

J1 Belt buckle (2008.3.58.6) – Oval iron buckle ring, the prong is pointed and goes over the ring. Its body is bent from thin bronze sheet, the upper part is reversed D-shaped, the lower one is smaller and square. It is fastened with two rivets, between the rivets and the prong it is decorated with engraved lines. 4.4x2.9. **J2 Belt end** (2008.3.58.4) – Made of bronze sheet, amphora-shaped. Decorated with a circle of dots in the middle, and 2 round holes and 2 bronze rivets on the side where the strap is fastened. 4.5x1.9, 0.08. **J3 Iron knife** (2008.3.58.3) – Single-edged knife, breaking at an obtuse angle in the back, its handle joins the blade in the middle. 15x0.4. **J4 Mug** (2008.3.58.1) – Swung strap handle on the upper part. Grey, narrow based, compressed spherical form, small everted rim, wide mouth. 10.3, 7.7, 4.1. **J5 Bowl** (2008.3.58.2) – Narrow based, deep, with rounded shoulder and small everted rim. 7, 13.8, 5.8. **J6 Awl** (2008.3.58.5) – Iron object square in cross section, one end is pointed. 10x0.8. **J7 Poultry bones.**

Q59 (Plate V, Fig. 5)

Rectangular grave with the end rounded (250x80, 65), contained the skeleton of a 30-40-year-old man of slight built with his head at the eastern end. The arms were lying bent on the chest. The

skull is tilted to the right shoulder. The feet were probably moved and so only partly remained as there may have been an animal borrow. A fragment of Celtic vessels was found in the earth of the grave.

J1 Bronze fibula (2008.3.59.4) – Big, bulbs ending in tips, one of tips broke down. Its bow is beautifully curved, decorated with diagonal grooving between two chased lines. Its catch-plate is trapezoid with chased points, at its start 2-2 and on its end 3-3 points in circles. Iron tongue. 9.5x4.8x3. **J2 Mug** (2008.3.59.1) – Swung handle, round in cross section. Material grey, granular but well-levigated. Narrow base, compressed spherical form, small everting rim. 8.9, 8.6, 3.6. **J3 Jug** (2008.3.59.2) – Spout, wide cylindrical neck, stretched compressed spherical form, decorated with two grooves on the shoulder. Brick-red material, the outside glazed greenish brown, stains of the glazing on the bottom. 19.5, 7.4, 6.8. **J4 Flint** (2008.3.59.9) – grey flint, under vessel J2 on the bottom of the grave. 2x2.5. **J5 Buckle** (2008.3.59.3) – Kidney-shaped buckle ring from cast trapezoid in cross section. The edge of the upper part of the plate fastening the strap is notched, the lower is straight and smaller. Two bronze rivets hold them together. The prong has not been found. The buckle ring narrows at the fixing plate, it is round in cross section. 3.1x3.6. **J6 Iron object** (2008.3.59.6) – Elongated, flat object. Narrower in one end and folded, widening and curved in the other end. Perhaps it was a fire striker. 8.5x2. **J7 Belt buckle** (2008.3.59.5) – Oval buckle ring, slightly compressed at the long side, with the fragment of the iron prong. The end of the plate fixing the strap is wavy, the rivets are roughly hammered. 5.2x3.8.



Fig. 5. Irregularly placed fibula in grave 59.

Q62 (Plate V)

It may have been a rectangular grave, which has been destroyed almost completely. The level of the grave may have been about 80 cm under the present ground-level. There was no skeleton in the grave but in the middle a Roman jug was found with glass pieces broken extremely small

around it. The fragments of a graphitic Celtic pot, other vessels, pieces of iron and a hardly recognisable loom weight were found in the grave earth.

J1 Jug (2008.3.62.8) – Material brick-red, stained with brownish green glazing everywhere even on the base. Small, has one handle. Narrow mouth, cylindrical neck, spherical body, widening base. 14.2, 3.4, 5. **J2 Glass** Its small pieces directly on the eastern side of jug J1 and partly under it.

Q83 (Plate VI-VII)

Horse-dog burial.¹⁰ The full-grown horse was almost folded and placed in the rectangular grave (180x110, 120), on its left side, with the head at the southern end. The head was bent on the spine, the legs pulled up. The remains of a large-sized dog tampered with a looter's pit were found at the rear legs (J6). The features show that the horse was half-harnessed when placed in the grave: the snaffle bit was in the mouth but the saddle was put on later. The fragment of a Roman brick was dug out c 40 cm above the level of the horse skeleton (J5), too.

J1 Part of the pommel (2008.3.83.3) – Iron pieces dovetailed in each other. Above the left ribs of the horse. 17x25. **J2 Part of the saddle fitting** (2008.3.83.1) – Object rectangular in cross section, broken at one end, pointed at the other. Curved at about 1/3 of the pointed end. 20x0.5x1. At the end of the right shoulder blade of the horse. **J3 Part of the pommel** (2008.3.83.4) – Iron pieces dovetailed in each other under the spinous process above the left shoulder blade. 17x24.5. **J4 Snaffle bit** (2008.3.83.2) – Between two iron rings of 9.5-10 cm in diameter a 13-cm-long rod round in cross section. 31x10. **J7 Fragment of buckle** (2008.3.83.5) – Oval buckle ring. The prong is semicircular in cross section, widening, the end is rounded. 5.9x4. **Buckle** (2008.3.83.6) – Oval buckle ring with prong. The buckle is longish, triangular and ends in a rosette. 6x3x0.2. **Fragment of a plate** (2008.3.83.7) – Fragment of a iron band with rounded end with the remains of two rivets. 3.7x1.8x0.2. **Fragment of buckle** (2008.3.83.8) – D-shaped buckle ring with broken prong. 5.2x4.2. **Buckle** (2008.3.83.9) – Oval buckle ring with prong. The buckle is longish, triangular and ends in a rosette. 7.2x3.3. **Fragment of buckle** (2008.3.83.10) – Narrowing buckle with rounded end and broken buckle ring. 5.4x3. **Fitting** (2008.3.83.11) – Riveted fragment. Widening at the rivet, the other part is L-shaped. 4x2.4. **Iron object** (2008.3.83.12) – Pointed ferrule on a small ring. 6x1.4. **Fragment of buckle** (2008.3.83.13) – Fragment of a round buckle body. 3.5x1.3.

Q84 (Plate VII-VIII, Fig. 6)

Tampered brick grave, the brick pieces found on the surface refer to this (Q11, Q89), round grave patch, several fragments of *tegulae* scattered around at a depth of 30-40 cm from the surface along the west side of the grave (J8, 9, 10) as well.

Q84J1: a skeleton of a 25-35-year-old woman oriented north-south was found among the tegula fragments. The arms of the dead with the head at the south end were beside the skeleton. The head was leaned against the triangular raising at the southern end of the brick grave. No sign of tampering was found on the skeleton; a row of Roman rimmed bricks was horizontally placed 20 cm lower. The skeleton was surrounded with brown humous filling mixed with yellow loess lumps, it sharply contrasted with the yellowish part under it. No grave goods.

¹⁰ Grateful thanks to Márta Daróczi-Szabó and László Bartosiewicz for the estimate of the animal skeletons. More: DARÓCZI-SZABÓ – BARTOSIEWICZ 2017.

Q84J2: The skeleton of a large-sized dog places on the south-western corner of the brick grave on the rim of the grave. Its position suggests that even the top of the brick grave was intact.

Q84J10: To construct a brick grave with an interior space of 195x65 cm, a larger pit was dug, which was walled with tegula fragments placed with their straight side towards the inside of the pit. The empty parts were either filled with smaller brick pieces (there was one piece of limestone, too) or moulded them with mud. The eastern and western sides are 6 row high and 1 tegula wide, but filled with brick fragments. At the uppermost row, a rim of about 5-5 cm was left for roof on both sides. The northern and southern ends were raised with 4 rows of bricks in the width of half a tegula like a tympanum. The bottom was covered with 4 tegulae, their flanges were broken off and that sides were put downwards. The sides began 5 cm higher than the bottom and were 5 cm wider. Downwards the grave bricks are smaller and smaller and there are many overburned and faulty. The grave sides were coated with 2-cm-thick chalky mortar at the grouting and partly on the bottom. When the bricks were removed, it turned out that the the bricks were “spared” from row 4 on the two shorter sides and the mortar was directly on the loess wall. The original grave was disturbed. The skeleton of the 30-35-year-old rather strong, robust man (**Q84J4**) lying stretched in supine position with the head at the southern end was completely ransacked, except for his right shin, hip bone, the left hand and the left fibula.



Fig. 6. Grave 84 during the excavation.

J3 Spear (2008.3.84.4) – Big iron winged spear. Two small processes perpendicularly join the lower part of the socket. Ribs run along the spearhead on the sides of the processes. L=35. **J5 Axe** (2008.3.84.5) – Haft-supported, straight-edged asymmetrical iron object with an oval haft socket that has the remains of the wooden haft. 12.4, edge length=11.3, poll length=7.4. **J6 Belt tip** (2008.3.84.1) – Silver, heart-shaped. It is closed with a double curve along two rivets at the strap side. 3.4x2.4. **J7 Belt buckle** (2008.3.84.2) – Silver, D-shaped buckle ring and strap fastening plate with three rivets. The prong is D in cross section, grooved in the front, its end

a slightly bent. 4.3x3. **J11 Glass** (2008.3.84.3) – Uncoloured, transparent, high-quality, conic. The rim is slightly inverted, cut, polished. Deep channelling under the rim, wide ground stripe below it, shallow cut line decoration on the lower part. The base is flat. 16, 10, 3. **J12 Folding knife** (2008.3.84.6) – one-bladed, triangular blade with oblique back. Its wide tang joins the blade at an obtuse angle. 20.5x5.4.

Q463 (*Plate IX*) Disturbed grave, so its exact form and measurements cannot be recorded. The grave contained the skeleton of a 7-8-year-old-child with the head at the eastern end. The upper part of the body must have been removed by an excavator. Otherwise the skeleton is was not touched but is in a rather bad condition, most of the smaller bones disintegrated.

J1 Mug (2008.3.463.2) – Small, grey, spherical, one-handled vessel with small slightly everting rim, narrow based. 6.5, 5.5, 3.1. **J2 Bowl** (2008.3.463.8) – strongly fragmented, burnt reddish brown, inverted rim. **J3 4 bronze coins** (2008.3.463.3) – Constantinus I, AE3. H: GLORIA EXERCITVS, 2 signums. Heraclea 330-333, ·SMHA·. RIC 121. (2008.3.463.4) – Constantinus I, AE3. H: DN CONSTANTINI MAX AVG / VOT XX. Ticinum 322-325, u // ST. RIC 167. (2008.3.463.5) – Constantinus I, AE3. H: GLORIA EXERCITVS, 2 signums. Aquileia 334-335, AQS. RIC 118. (2008.3.463.6) – Constantinus I, AE3. H: GLORIA EXERCITVS, 2 signums. Constantinopolis 333-335, CONST·. RIC 73. **J4 Iron knife** (2008.3.463.7) – Fragment of small thin blade. One-bladed, straight back. 8.3x1.8. **J5 Mug** (2008.3.463.1) – Grey vessel with high-swung strap handle, wide base, bi-conical body, small everting rim. 11.5, 10.4, 5.4.

Q464 (*Plate IX*)

Grave with ravaged trunk and right thigh bone. The patch of the grave was invisible in the loess. The the skeleton of a 30-50-year-old woman with her head at the eastern end was found at a depth of about 50 cm from the cleaned topsoil. Down from the thigh bones it is unimpaired. No grave goods remained at the upper part of the body.

J1 Bowl (2008.3.464.2) – Brown, with inverted, conical-frustum-shaped. 5.5, 18.2, 8. **J2 2 bronze coins** (2008.3.464.27.) – Constans AE4. H: VICTORIAE DD AVGG Q NN, 347-348. Worn. (2008.3.464.28.) – from the 4th c., completely worn AE4. **J3 Jar** (2008.3.464.30) – Terracotta material, with green glazing, which does not completely cover the outside but stains can be found on the bottom as well. Profiled rim, long cylindrical neck, elongated oval body, wide base. Its handle with finger support is between the rim and the widest part of the body. 27, 7.4, 8.4. **J4 Mug** (2008.3.464.1) – High-swung strap handle, narrow base, bi-conical form. Small everting rim. The surface burned in spots. 9.4, 7, 3.9. **J5 Iron knife** (2008.3.464.29) – Short curved edge, back bending at an obtuse angle. Its tang is broken, joins the blade in the middle. 9.8x2.8. **J6 23 bronze coins** (2008.3.464.3) – Constantius II, AE3. H: FEL TEMP REPARATIO, rider. 351-361. (2008.3.464.4) - Constantius II, AE4. H: SPES REIPVBLICE. Siscia 355-361,]ISN. (2008.3.464.5) – Constantius II, AE4. H: SPES REIPVBLICE. Siscia 355-361, ASIS[. (2008.3.464.6) – Constantinus-dyn. AE4. H: SPES REIPVBLICE, 355-361. (2008.3.464.7) – Constantius II, AE4. H: SPES REIPVBLICE, 355-361. (2008.3.464.8) – Constantius II, AE4. H: SPES REIPVBLICE, 355-361. (2008.3.464.9) – Divus Constantinus AE4, H: VN-MR, 347-348. (2008.3.464.10) – Constantius II, AE4. H: SPES REIPVBLICE, 355-361. (2008.3.464.11) – Constantinus-dyn. AE3. H: FEL TEMP REPARATIO, rider, 351-361. (2008.3.464.12) – Constantius II, AE4. H: SPES REIPVBLICE, 355-361. (2008.3.464.13) – Constantius II, AE4. H: SPES REIPVBLICE, 355-361, I /. (2008.3.464.14)

– 4-5th century, completely worn, bronze. (2008.3.464.15) – Constantinus-dyn. AE4, completely worn, 306-364. (2008.3.464.16) – Constantius II, AE4. H: SPES REIPVBLICE, 355-361. (2008.3.464.17) – Constantinus-dyn. AE4. H: SPES REIPVBLICE, 355-361. (2008.3.464.18) – Constantinus-dyn. AE3. H: FEL TEMP REPARATIO, rider, 351-361. (2008.3.464.19) – Constantius II, AE3. H: FEL TEMP REPARATIO, rider, 351-361. (2008.3.464.20) – Constantinus-dyn. AE4. H: SPES REIPVBLICE, 355-361. (2008.3.464.21) – Constantius II, AE4. H: SPES REIPVBLICE, 355-361. (2008.3.464.22) – Constantinus II, AE4. H: GLORIA EXERCITVS, 1 signum. Nicomedia 336-337, SMN[. RIC 200. (2008.3.464.23) – Valentinianus I, AE3. H: GLORIA ROMANORVM, emperor with prisoner. Siscia 367-375, / D, *BSISC. RIC 14a/11. (2008.3.464.24) – Valentinianus I AE3. H: SECVRITAS REIPVBLICAE. Aquileia or Siscia, 364-375, D /, ? (2008.3.464.25) – Constans AE4. H: VICTORIAE DD AVGG Q NN, 347-348. (2008.3.464.26) – Constantius II, AE2. H: FEL TEMP REPARATIO, rider. Aquileia, 348-354, E.: N /, H.: ·AQP. Fragmented.

Q465 (Plate V)

Most parts were taken by the excavator, only one part of the leg bones remained in the section. Among them, the pieces of a glass vessel can be seen. The grave was obviously oriented east as the other Late Roman graves. The grave patch cannot be seen anywhere in the loess.

J1 Glass vessel (2008.3.465.1) – Fragments of light green, translucent vessel made of bubbly material. 3.7; 3; 2.6.

Q498 (Plate X, Fig. 7)



Fig. 7. Grave 498.

Long rectangular grave with the end rounded. (270x80, 80) with the skeleton of a 40-50-year-old woman stretches in supine position with her head at the eastern end. The place of the bones suggest that the deceased was placed in the grave on some kind of platform or divan. The head must have been on a cushion-like stand because it is on a c 20 cm higher level than the level of the trunk. The right forearm lies on the stomach, the left forearm on the inner side of the left hip bone. The trunk and the legs are on about 20 cm higher position than the bottom of the grave while the thigh-bone and the pelvis are directly on the bottom. The right hand fell almost about 10 cm under the elbow, the feet are in the same anatomical position but on in their place.

J1 Beads (2008.3.498.2) – 4 pieces, bi-conical, dark blue glass. 0.4x0.3. **J2 Bracelet** (2008.3.498.10)

Twisted of 3 bronze threads, hooked-looped clasp. At the ends bronze plate fixes the threads. 7x6.6.

J3 Bone bracelet (2008.3.498.5) – Wide band with a chased line along the middle. The ends narrow, fixed with 2 bronze rivets. The curve

suggests an object with a bigger diameter than that of a bracelet. Fragmented. Width=0.8. **J4 2 Bronze coins** (2008.3.498.6) – Constantius II AE3. H: GLORIA EXERCITVS 2 signums. Thessalonica 330-333, 335-336. SMTSF. RIC 186, 200. (2008.3.498.7) – Constantius II AE3. H: FEL TEMP REPARATIO, rider, 351-361. E.: A /. **J5 Iron rod** (2008.3.498.4) – Round in cross section, solid, one end is pointed. 25.6x0.8. **J6 Bronze coin** (2008.3.498.8) – Constantinus I AE3. H: GLORIA EXERCITVS 2 signums. Siscia 334-335, ·ASIS·. RIC 235. **J7 Bronze coin** (2008.3.498.9) – Constantinus I AE4. H: GLORIA EXERCITVS 1 signum. Siscia 337, JSIS*. RIC 261. **J8 Mug** (2008.3.498.3) – Low, compressed spherical form. Narrow based, wide mouthed, with a plain strap handle beginning at the small everted rim and joining the middle of the body. 14, 10.8, 4.8 **J9 Bowl** (2008.3.498.1) – Conical-frustum-shaped bowl with rounded rim. Shiny black smoothed-surfaced and on the bottom with 4 burnished lines crossing each other in star form and incised lines. 4.5, 16.8, 11.2.

Q501 (Plate XI)

Regular rectangular shaped grave (250x100, 100), with vertical walls and a flat bottom, with light brown humous filling. In the grave the skeleton of a 45-55-year-old woman was found with her head at the eastern end. Both of her forearms were bent to the trunk so that the right hand was on the left hip bone, the left hand on the right one among the ribs. There was an oxide spot (J4) above the left collar bone.

J1 Bronze coin (2008.3.501.1) – Galerius Maximianus, follis. H: GENIO AVGUSTI. Nicomedia 308-310, SMNA. RIC 54a. In good condition. **J2 Bronze coin** (2008.3.501.2) – Maximianus Herculius, follis. H: Sacra Moneta, Ticinum 304-305, / *,]T. RIC 47b. In good condition. **J3 Fibula** (2008.3.501.8) – Open, bronze ring fibula. Made of a band rectangular in cross section, the ends are flattened, coiled. Tongue was not found. 3x2.8. J4 Oxide spot, not individual grave furniture, belongs to J3. **J5 Bracelet** (2008.3.501.6) – Slightly oval bone ring, ends are narrowed, bent on each other. Joined with bronze rivets. 6x5.8. **J6 Bracelet** (2008.3.501.5) – Closed bronze ring, about D in cross section. On one part trace of wearing. 6x5.6. **J7 Fragment of bracelet** (2008.3.501.7) – Slightly oval bone ring, ends are narrowed, bent on each other. Joined with bronze rivets. 6.1x5.1. **J8 Glass** (2008.3.501.10) – Light green, translucent, strongly bubbly material, slightly deformed, conical body. Upward rim thickened, fire rounding rim. Base narrow, flat. Unadorned. 13.1, 7.8, 1.6. **J9 3 bronze coins** (2008.3.501.3) – Valentinianus I, AE3. H: SECVRITAS REIPVBLICAE, with Victoria festoon. Siscia 364-367, ·ASISC. RIC 7a/2. (2008.3.501.4) – Gratianus AE3. H: GLORIA ROMANORVM, emperor with prisoner. Siscia 367-375, S / D*, (sisc). RIC 14c/14. (2008.3.501.9) – Constantius II, AE4. H: SPES REIPVBLICE type. 355-361. Broken.

Q502 (Plate XI, Fig. 8)

Regular grave with vertical walls and a flat bottom, its spot was invisible so its exact measurements cannot be stated (c 200x60, 110). In the grave lay the skeleton of a rather small 50-60-year-old man with her head at the eastern end. The head is tilted on the breastbone, the chin is on the breastbone as if the skull had been supported with something. The arms are bent, the hands are on the line of the spine. The left arm is laying about 10 cm higher than the middle of the breast as if there had been something under it.



Fig. 8. Grave 502.

J1 8 bronze coins (2008.3.502.4) – Constantinus-dyn. AE4. H: SPES REIPVBLICE. Aquileia, 355-361,]AQP[. (2008.3.502.5) – Iulianus AE4. H: SPES REIPVBLICE, 355-361, E /, ?. (2008.3.502.6) – Iulianus AE4. H: SPES REIPVBLICE, 355-361, S /, ? (2008.3.502.7) – Constantius II, AE4. H: SPES REIPVBLICE. Aquileia 355-361, AQS. RIC 235. (2008.3.502.8) – Constantius II, AE4. H: SPES REIPVBLICE. Sirmium 355-361,]SIRM. RIC 80. (2008.3.502.9) – Constantius II, AE4. H: SPES REIPVBLICE. Cyzicus 355-361, SMKS. RIC 117. (2008.3.502.10) – Constantius II, AE4. H: SPES REIPVBLICE, 355-361. (2008.3.502.11) – Constantius II, AE4. 337-361. Rather worn. **J2 Bronze coin** (2008.3.502.3) – Constantius II, AE4. H: SPES REIPVBLICE. Siscia 355-361, · / ·, BS[. RIC 405-406. **J3 Iron knife** (2008.3.502.13) – Short curved blade, back bending at an obtuse angle. Its long tang joins the blade in the middle. 12x2.3. **J4 Mug** (2008.3.502.1) – Small, pear-shaped, with slightly everting rim. The handle broke with a part of the rim, not found. 10, 6, 4.2. **J5 Vessel** (2008.3.502.2) – Jar-like. Wide base, conical body, wide, cylindrical neck, a bit everting rim. The high-swung strap handle begins at the rim and joins the body in the middle. Smooth surfaces on the neck vertically, on the shoulder horizontally, on the lower part vertically. 15.5, 8, 6.8. **J6 Glass** (2008.3.502.12) – Light green, good quality, transparent, conical body. Slightly everting rim, a bit thickened, fire rounding rim. Base narrow, flat somewhat pressed. Unadorned. 13.2, 8.4, 2. **J7 Poultry bones**.

Q503 (*Plate XII-XIII, Fig. 9*)

Q503 (*Plate XII-XIII, Fig. 9*)

Rectangular, regular grave, well outlined on the surface, with vertical walls and a flat bottom (250x120, 130). In the grave, the skeleton of a 15-17-year-old person was found stretched, with the head at the eastern end. The head and the left part of the trunk were tampered. The right forearm was placed on the pelvis. The left forearm and the hand are between the thigh-bone and the hip bone on the inner side of the thigh-bone. The two legs are stretched, the feet tilted outwards.

J1 Bracelet (2008.3.503.10) – Twisted of 3 bronze threads with an oval hooked-looped clasp. 5.8x5.4. **J2 Bracelet** (2008.3.503.11) – Made of thin bronze plate, with a hooked-looped clasp. Decorated with chased wavy lining. 4.9x5.4x0.4. **J3 Bracelet** (2008.3.503.9) – Round-ringed bone bracelet, round in cross section, obliquely grooved on the outside. The ends are narrowed, bent on each other fixed with bronze rivets. 6.8x6.8. **J4 Bracelet** (2008.3.503.17) – Hooked-looped clasp. Made of 3 bronze threads, decorated with dark blue polyhedral glass beads. 6.2x6.2. **J5 Finger ring** (2008.3.503.8) – Bronze ring, round in cross section, widening oval at the head. Decorated with chased lines crossing each other. 2x2.4. **J6** Tiny amorphous iron pieces (4). **J7 Iron rod** (2008.3.503.16) – Round in cross section, solid, one end is pointed. 27x0.9. **J8 Bronze**

coin (2008.3.503.13) – Constantius II AE4. H: GLORIA EXERCITVS, 1 signum. Siscia, 335-336, GSIS. RIC 254. **J9 Bowl** (2008.3.503.2) – Conical-frustum-shaped, incurved, with downcurved rim. 3.7, 13.4, 7.5. **J10 Jar** (2008.3.503.7) – Grey, pear-shaped, narrow-based, flared and ribbed neck, everted rim. The handle begins at the rim and joins the body in the middles. 25, 7.6, 6. **J11 Mug** (2008.3.503.1) – Narrow-based, spherical body, wide mouthed. The rim is everted, the slightly swung strap handle begins here. 12.5, 9.5, 5.4. **J12 Iron knife** (2008.3.503.18) – The long tang joins the short, humpbacked blade in the middle. 17.5. **J13 Poultry bones**. **J14 Necklace** (2008.3.503.3-6) – Consists of 24 blue, 2 green, 4 light brown bi-conical, 70 small and 12 medium-sized spherical, 1 double spherical gold-foiled, 1 big, hexagonal, brick-shaped, prismatic and 5 smaller hexagonal prism-shaped glass beads. **J15 Bronze coin** (2008.3.503.12) – Constantinus I, AE3. H: GLORIA EXERCITVS, 2 signums. Antiochia, 335, SMANΔ. RIC 86. **J16 2 bronze coins** (2008.3.503.14) – Constantinus II, AE3. H: GLORIA EXERCITVS, 2 signums. Cyzicus 331, 333-4. SMKT. RIC 81. (2008.3.503.15) – Constantinus-dyn. AE4. H: GLORIA EXERCITVS, 1 signum. Nicomedia 337-340, SMN[.RIC 6, 10. **J17** Green oxidised metal threads, perhaps decoration of textile. From the area of the ribs.



Fig. 9. Grave 503.

Q507 (Plate XIII)

Regular trapezoid grave widening at the head (200x45-60, 12) with the skeleton of a 40-50-year-old man lying stretched in supine position with her head at the eastern end. The head is tilted towards the left shoulder, the upper arm stretched beside the body, the left forearm placed on the stomach, the right forearm to the pelvis. The legs are stretched, the left foot tilted to

the left, the right foot fell on it. The red colouration found under the left shin can be seen in several places under the bones around the trunk. The fragments of Celtic pottery and some animal bones as well were found in the grave earth.

J1 Glass object – Perhaps the small fragments of a base-ringed glass. **J2 Fibula** (2008.3.507.3) – Open iron ring fibula. The ends are flattened, coiled, square in cross section. The stem and the tip of the tongue rusted on the ring, the other parts were not found. 5.2x4.8. **J3 Belt buckle** (2008.3.507.2) – Oval, bronze buckle ring with bent prong. The strap fastening is square with notched edge and 2 rivets. The lower part is smaller. 4.4x2.4. **J4 Belt tip** (2008.3.507.1) – Amphora-shaped, bronze, decorated with chased concentric circles in the middle. The strap fastening is double curved, two rivets. 3.8x3.5. **J5 Iron knife** (2008.3.507.4) – Wide, short-bladed, one-edged, the back is curved. The tang is joined to the blade in the middle. 14x4.8.

Q517 (*Plate XIII*)

The skeletons 517 and 518 must have been buried in a shared grave as the features show. In grave Q517 an 18-20-year-old woman(?) lay, irregularly compared to the other burials, with the head at the southern end. The head must have been disturbed during soil cultivation, only the lower jaw and a part of the upper jaw were found above the collar bone at the left shoulder. The whole left arm stretched beside the body, the right arm was bent, the hand was on the stomach. The legs were stretched, the feet lay over the shin bones. No grave furniture was found.

Q 518 (*Plate XIII*)

As the features show, this is the grave of 9-11-year-old child buried with Q517 in the same grave. The child lay with the head at the southern end directly on the left side of skeleton Q517, stretched parallel with it. Both arms were bent, the right hand was placed at the pubic bone, the left hand on the stomach. The legs are stretched, the bones of the feet were not found, they probably crumbled.

J1 Ring (2008.3.518.3) – Round in cross section, closed bronze ring with traces of wear. D=3.7, 0.3. **J2 Fibula** (2008.3.518.2) – Open iron ring fibula. Square in cross section, the ends are broken, the tongue is intact. 4.4. **J3 Ring** (2008.3.518.4) – Square in cross section, closed circle. Maybe silver-gilt bronze? D=2.1, 0.3. **J4 Mount** (2008.3.518.1) – Round, with protruding circular central part, place of an ornament or inlay. Two lugs are needed to fasten it. 2.6x2.6x0.9.

Q520 (*Plate XIV*)

Rectangular grave with vertical walls and a flat bottom (250x100, 40), light brown humous filling with dark brown spots, with the skeleton of a 30-35-year-old man lying stretched in supine position with her head at the eastern end. The head is tilted towards the right shoulder, the whole trunk is compressed as if it had been wrapped in textile. The upper arms partly cover the ribs, the right forearm is bent to the left shoulder, the left forearm under the right elbow. The legs are stretched, the right foot is tilted. In spite of the large size, the grave is poor in grave goods.

J1 Fibula (2008.3.520.2) – Ornamented with big bulbs, with dotted circles on the catch-plate. (Unknown place). **J2 Piece of marble** (2008.3.520.1) – Thin, angular marble slab. The sides are smooth, polished. On one side there are thin rust lines crossing each other. 3.6x5.4x0.9.

Q522 (*Plate XIV*)

Rectangular grave with the ends rounded (160x60, 30) with the skeleton of a 3-5-year-old child in supine position. The head is tilted towards the right shoulder, the left arm is bent, the hand rests on the right shoulder. The right arm is slightly bent, the digital bones end at the right hip bone. The legs are stretched, the bones of the feet were not found. The bones are in a very bad condition, most of them disintegrate. The poultry bones are on the area between the bent left forearm and the right shoulder, so this shows that the grave goods must have been placed here.

J1 Bronze coin (2008.3.522.1) – Crispus, AE3. H: CAESARVUM NOSTRORVM / VOT / X. Siscia, 321-324, ΔSIS sun. RIC 181. **J2 Bronze coin** (2008.3.522.2) – I. Constantinus, AE3. H: PROVIDENTIAE AVGG, gate of the camp. Nicomedia, 328-329, SMNT. RIC 153. **J3 Iron knife** (2008.3.522.3) – Short bladed, single-edged knife with curved back. The tang joins the blade in the middle, broken. 8.5x2.1. **J4 Iron tool** (2008.3.522.5) – Both ends narrowed, rectangular in cross section. Drill or drill bit? 8.8x0.8. **J5 Vessel** (2008.3.522.6) – Wide-mouthed, round-shouldered, wide-based vessel with everted rim. 13.6, 11.6, 5. **J6 Finger ring** (2008.3.522.4) – Round rimmed bezel soldered to a ring made of bronze wire, round in cross section. Remains of glass-paste inlay. 2.3x2.

Dombóvár-Újdombóvár, Public Cemetery

In the area of the Újdombóvár Public Cemetery, the fragments of a small bowl and a glazed jar were found in the ditch dug beside the pit of a water meter on 10 March 2010. Imre Topa, site manager reported this to the museum. During the rescue excavation, a burial site was found, similar to the earth graves introduced above.¹¹ No other grave came to light in the line of the ditch.

Description of the grave and objects

Q1 (*Plate XV*)

Rectangular grave with the corners rounded (110x60, 100-110). A thin person lying stretched in supine position was buried with the head at the eastern end. The skull, the left forearm and the legs were disturbed. The bent arms were found further from the ribs. The lower parts of the legs were badly stirred, the feet and shin bones were not found. The jar was found in this area and so was the small bowl handed over to the Collection of Local History by the person reporting the finds later.

J1 Jar Glazed jar with one handle, with brownish yellow glaze stains on the surface. Steep-sided, round-shouldered small vessel narrowing at the base. With cylindrical neck, profiled rim. Handle not found. 17.5, 2.7, 4.5. **J2, J4 Finger rings**. Unadorned bronze wedding rings round in cross section on the ring finger of the left hand. The ends bend on each other. 2.1x2.1x0.2. **J3 Bracelet** Made of bronze, open, decorated with stylized snake heads in the ends. 6.4x6.1x0.3 **J5 Bowl** Grey, conical-frustum-shaped, with inverted rim, smooth surface. 3.7, 12.7, 9.2.

¹¹ BORUZS – SZABÓ 2010.

The assessment of the burials

The objects of the grave furniture and their execution are similar to the those found in the already-known Late-Roman cemeteries of South-Transdanubia. The jewels, fittings of clothes, coins for the journey, vessels for food and drink, sometimes small necessities of everyday life, tools, devices were also buried with the dead. Though the graves at Kiskondai Stream (22 graves, with 24 burials!) and in Újdombóvár (1 grave) are introduced together as they belong to the same age and the burial customs are similar, they are not parts of the same cemetery.

Grave forms and orientation

Out of 23 graves 20 are east-west oriented, rectangular, simple earth graves. Though several were disturbed in later times, the burial customs of the Roman age can be observed very well. The dead were buried lying in supine position with the head at the eastern end, arms stretched beside the body either on the chest or placed on each other on the pelvis. In contrast to this, from the place of the bones in one of the graves it can be concluded that the deceased was placed not on the earth but on a divan-like object (Q498). In another case the hunched shoulders and the arms placed closely beside the body suggest that the deceased was wrapped in a shroud (Q520). As the grave was covered over immediately after the burial, the earth kept the bones – especially the skull – and the vessels intact. In contrast to this, in a grave with a noticeable large square spot, (Q40) both the skull and the vessels were found in bad condition, completely compressed. The dark brown streak along the edges of the grave suggests that the grave was lined and covered with planks, which fell in after the wood had rotted and broke the bones and vessels.

The 3 south-north oriented graves were found further from each other. The south oriented double earth grave (Q517-518) was among the east-west oriented earth graves at the western edge of the cemetery with 22 graves. The woman aged about 18-20 (Q517) had no grave goods, the 9-11-year-old child beside her was buried with bronze mounts belonging to the clothes and an iron fibula. A little further on, at the eastern end of the excavation, there were two separate graves also south-north oriented. A horse with the snaffle bit in the mouth and the saddle probably put on later lay in the earth grave, and with the skeleton of a full-grown dog at the legs (Q83). About 2.5 m from here was the brick-walled grave with a roof-like cover (Q84). Originally a 30-35-year-old rather strong, robust man was buried here (Q84J4), later the grave was ransacked and looted, then a woman aged about 25-35 was placed among the brick fragments – oriented the same way but without grave goods (Q84J1). As there was no datable grave furniture, the time of robbery and burial over the original grave is not known. The grave goods found in the brick grave (silver belt buckle and strap tip, winged spear, knife, adze) indicate that the man may have been well off, buried with his own horse and dogs. The identical orientation of the two graves also suggests this. Similar burial was excavated in the nearby Mágocs: near three, west-east oriented graves built of brick and stone slabs lay two horse skeletons orientated the same way. It was not possible to establish any connection between the grave and the horse burial here either.¹²

12 GÁBOR 1998, 113.

Grave furniture

When examining the burials, we have to keep in view that we cannot analyse the whole cemetery, only one part is excavated and one part of the graves were tampered, so we cannot have the full picture of the grave furniture. The traces of contemporary ransacking can be observed in the case of 5 graves out of 22 in the cemetery at the Kiskondai Stream, 1 shows the traces of later agricultural work and 3 those of tampering, the latter happened to the grave in Újdombóvár as well. Two deceased were buried without grave goods (Q84J1 and Q517). 4-6 objects and coins (1-26 pieces) were also put in most of the graves to help the afterlife. The graves of the two girls can be considered the richest (Q56, 503), besides money the 9-17-year-old deceased had 11 pieces of grave goods – first of all jewels.

Pottery

In the graves, earthenware vessels were generally placed to the feet of the dead, in the case of children near the head. The jars, mugs, bowls were made of clay, the vessels for serving drinks were already made of glass in several cases. In the cases of Q501 and 507 no pottery, just glass was found; however, from graves 517-518 and 520 no vessel was put in the grave beside the dead person.



Fig. 10. Vessels of grave 59 (left), burnished vessel from grave 502 (center), grey bowl from grave 58 (right).

The 7 jars vary in appearance: their form can be tall or small, slim or stubby, the surface glazed or smoothed but they all (at least originally) had one handle. The glazed jar was one of the most characteristic type of vessels in that age, which was produced in Pannonia from the middle third of the 4th c. to the first half of the 5th c.,¹³ based on the coins found in the graves in Dombóvár they can be dated at the reign of Constantius II and Valens. The brownish green glazed variations of smaller, 14-20 cm tall jars have been excavated, they had spherical body, cylindrical neck, straight rim and one handle (Q41, 62, 1). The only with greenish brown glazing (Q59) also belongs to this range of dimensions (*Fig. 10, left*). The bigger, 27-29 cm tall jars (Q40, 464) are pear-shaped, with neck ring, funnel-shaped everted rim, one handle and brownish green glazing. The only grey jar of this part of the cemetery (Q503) was placed in the grave with minted coins between 331 and 340.

The other characteristic of the Late-Roman period is the smoothing of the surface:¹⁴ this can be seen on 2 vessels (*Topfbecher*) and 4 bowls. On the lower part of the body of the vessel found in

13 OTTOMÁNYI 2011, 277.

14 OTTOMÁNYI 2007, 202; recently: HORVÁTH 2016.

grave 54 vertical, on the shoulder horizontal smoothing fill the surface. The surface of the jar from grave 502 is similar, too, vertical smoothing can be found on the cylindrical neck as well (*Fig. 10, center*). The stubby, round-shouldered, one-handled vessels are dated by coins of Constantius II and Valens II, they were dug up from the burials of a woman (Q54) and a man (Q502).

A mug was placed in the grave in 8 cases (Q57, 58, 59, 463, 464, 498, 502, 503), all of them were simple, grey, spherical, one-handled vessels with small everting rim, made of granular material. Their height ranged from 8 to 12 cm. The vessel of grave 522 is slightly different: has no handle and is 13.6 cm tall. In grave 463 two mugs were put but in this case – it was a grave of a child – the bigger one can be considered as storage vessel (jar) and the smaller as drinking vessel (glass). Apart from this, two vessels with the same function, pottery mug and glass, were only found in a grave (Q502).

Most of the bowls were simple conical-frustum-shaped, average in the period, slightly thickened ringed or inverted rimmed. In 6 graves (Q39, 40, 57, 464, 503, 1) there were vessels of 13-18 cm in diameter, burnt grey or brownish, made of granular material. The grey bowl of grave 58 has a different shape (*Fig. 10, right*), the rounded shouldered and the deep, glazed bowl of grave 40 is also diverse with its horizontally everting rim. Smoothed bowls with shiny surface were found in 4 graves (Q41, 56, 57, 498), their measurements are similar to those of house pottery bowls, they are can be dated by coins at the reigns of Constantius II, Valentinianus I and Valens. The shiny black surfaced bowl of grave 498 (*Fig. 11*) is decorated with three 3 short incised oblique lines. On the bottom there are smoothed bands running to the edge and crossing each other in star shape as well as incised irregular lines.¹⁵



Fig. 11. Burnished bowl from grave 498.

Glass vessels

Personal possessions made of glass were placed in 8 graves of the cemetery (more than third of the uncovered graves). Graves 62 and 465 contained extensive damaged fragments, which do not make any identification possible. The features in grave 507 suggest that a low glass with a base ring was placed beside the deceased, in graves 39, 84, 501, 502 tall conical ones without base ring were found (Barkóczi 1988/47, Dévai 2012/P9 type).

¹⁵ The meaning of incised and smoothed signs: HORVÁTH 2016, 47-49.



This type is quite common in Pannonia, it appears in graves of the first third of the 4th c. up to the beginning of the 5th c.,¹⁶ which is confirmed by the coins found in the graves in Dombóvár, too. The glasses of graves 39, 501, 502 are 10-13 cm tall, unadorned, while a bigger 16 cm high-quality, tall glass with ground ornamentation belonged to brick grave 84 (*Fig. 12*). In grave 56 a very thick-walled dark green base was found: the fragment of a spindle-shaped scent bottle (Barkóczy 1988/103, Dévai 2012/I18). This form can be found over the 4th c., larger and smaller versions are known as well.¹⁷ As there was no other glass fragment besides the base in the grave in Dombóvár, probably the whole vessel was not placed in the grave, so perhaps it had a secondary function.¹⁸

Fig. 12. Tapered glass form grave 84 (during restoration).

As for their position in the grave, the glasses were found on the chest (Q39, 84), at the shoulder (Q507), near the legs (Q501, 502) or the thigh (Q465), the base of the scent bottle was above the head (Q56).

Garment accessories

Fibula was placed beside the dead in 6 cases. Crossbow brooches (*Fig. 13*), considered as the most characteristic element of a man's garment, were uncovered in the graves of three, about 30-50-year-old men (Q40, 59, 520), the B variants of Keller-Pröttel 3/4 type used commonly and for a long time in Pannonia.¹⁹ While in graves 40 and 520 they were placed on the right shoulder, i.e. where they were normally worn, in grave 59 one was found with the tongue upwards under the head. This may refer to the fact that the cloak was folded and put under the head. Besides the fibula there were coins minted between 350-361 (21 pieces) and glazed vessels in timbered grave 40, and a glazed jar and oval-shaped bronze buckles in grave 59, but in grave 520 there was only a small marble slab.



Fig. 13. Crossbow brooch from grave 40.

16 DÉVAI 2012, 162-164.

17 DÉVAI 2016, 267, 279-280.

18 K. Dévai's opinion is that they may have been used as stoppers (DÉVAI 2012, 224-225), however, we do not think it is very likely in this case.

19 KELLER 1971, 34-35; PRÖTTEL 1991, 357-364; recently: MERCZI 2016, 466-467.

Three ring fibulae (Riha 8.2 type)²⁰ were unearthed in graves 501, 507 and 518, the first is small-sized, bronze, the other two are bigger and made of iron. They were found at the right collar bone of the middle-aged woman and man (Q501, 507) and near the right femur in the grave of a child (Q518) with a small bronze ring. In Pannonia, this type of fibula is quite usually found in graves of women and children as well, but as for the function the ones found around the pelvis are rather considered to be belt or bag buckles.²¹ The deceased of these graves were buried first of all with the objects belonging to their everyday wear (bracelet, belt, but glasses, one to each, were also put in the graves of the two adults. Valentinianus I and Gratianus coins found in grave 501 helped their dating.

The individual parts of a belt (buckle, strap tip, mount) considered men's garment accessory are known from graves 58, 59, 84, 507 and 518. Belt buckles and strap tips were found in 3 graves, in grave 84 made of silver, in graves 58 and 507 made of bronze. Buckles with an oval plate and D-shaped buckle ring, with square plate and oval or kidney-shaped buckle rings as well as amphora- or heart-shaped strap tips were popular in the second half of the 4th c. In Pannonia they can be dated at the Constantius II-Gratianus period,²² the grave goods of the Dombóvár graves do not modify this. The simple bronze ring in grave 518 was probably a belt buckle, it was unearthed at the sacrum. It is questionable whether the mount belonged to the belt (button, ornament) or to some other part of the garment. In grave 59 there were even two square-bodied, oval-ringed buckles (*Fig. 14*), one at the pelvis, the other at the left shin-bone. The latter may have closed a bag used for storing fire-lighting tools (fire-striker and flint), which were found near the buckle. The placement of belt sets and accessories in the grave is determined by the way the deceased was laid in the grave with the belt on or the belt was put in later. So the dead of graves 59, 84 and 518 were probably buried with their belts round their waists, while the folded belt with a knife on it was placed on the stomach of the dead person in grave 58, the procedure was the same in the case of grave 507 but there the belt was between the shin-bones.



Fig. 14. Buckles from grave 59.

20 RIHA 1979, 209; recently with research history: MERCZI 2016, 457-459.

21 MERCZI 2016, 457.

22 KELLER 1971, 59-60; recently with parallels: KELEMEN 2008, 100-101.

In the 7 Dombóvár graves, introduced now, men were buried (Q40, 58, 59, 84, 502, 507, 520), but there was only one in whose grave (Q502) there was no part of fibula-belt set. Likewise, the characteristics of the graves of women, jewels, can be found in almost every grave (Q39, 54, 57, 498, 501). In the case of two burials (Q464, 517), it cannot be stated whether there were any as they were disturbed at the area of the head and arms. It is certain that no jewel was placed beside the woman (Q84J1) subsequently buried in the brick grave. In the graves of children (Q41, 56, 463, 503, 518, 522), girls were buried with bracelets, necklaces and finger rings (Q56, 503, 522).



Fig. 15. Bone hairpin adorned with woman's bust from grave 56.

The most grave goods were found in the grave of a 9-11-year-old girl (grave 56): she was buried with a hairpin (Fig. 15), earrings, a string of beads, 3 bronze bracelets and a finger ring and 17 coins were also put in her grave. 13 of the coins, minted between 337 and 361, lay "rolled" near the left hand. This dates the only hairpin found in the cemetery. It was made of bone and belongs to the group adorned with woman's bust. The slightly different hairdo distinguishes it from its parallels²³: on the two sides of the face and at the forehead the hair is swept back.

Earrings were uncovered in 3 graves (Q54, 56, 57), the ones in grave 56 was silver, the others bronze. One of the earrings found in grave 57 has a conic bronze pendant, too, but the bead closing the earring was missing. All the three pairs of earrings can be classified as hooked-looped clasped, which were found with several types of ornaments during the 4th c., but the variations both with bronze pendants and beads were popular from the middle of the century.²⁴ In the graves in Dombóvár, besides the smoothed-surfaced vessels (Q54, 56), bronze bracelets and iron rods (Q56, 57), there were coins minted in 337-361 (Q56) and 364-378 (Q54) as well.

There were necklaces in a quarter of altogether 12 burial sites of women / girl, in the graves of two young persons (Q56, 503) and one older woman (Q498), in the usual position of wearing. Though several necklaces are known from this age, the beads vary in material, colour, form and technique²⁵, few examples were found in Dombóváron. Generally, in the graves of adults simpler, in those of children more colourful necklaces were found.²⁶ The simplest was uncovered from grave 498: the necklace consisted of 4 bi-conical, dark blue glass beads, the string must have been some organic material. The necklace from grave 56, which was strung on a thin bronze wire, consisted of small dark blue beads, and had a bronze clasp. The necklace of grave 503 (Fig. 16) was the longest, perhaps it was also strung on a bronze wire but its clasp has not remained. It consisted of 119 coloured glass beads of various forms: besides the small

23 BARTUS 2007, 192-193. Closest parallel: Bátaszék-Kövesdpuszta 101. grave (PÉTERFI 1993, illustration XIV).

24 FACSÁDY 2009, type III; KELEMEN 2008, 117-118 with parallels.

25 KELEMEN 2008, 124-126; recently: BORUZS 2016, 391.

26 KELEMEN 2008, 124.

blue, green, light brown bi-conical, spherical and prismatic beads, a gold-foiled and a big, greenish blue, iridescent, prismatic beads embellished the necklace. The glittering gold-foiled or gold-glass beads appeared already in the 2nd-3rd c. but became frequently used in the 4th c. Generally 1-2 such beads were strung in a necklace, probably because of their high price.²⁷ This grave is dated by coins minted in Dombóvár between 331 and 340.



Fig. 16. Beads from grave 503.

From 7 graves altogether 18 bracelets were unearthed, 14 made of bronze and 4 of bone. The bronze bracelets can be divided into five groups. Type 1: simple, unadorned, D in cross section, closed circle which is made, first of all, of glass, jet, lignite; bronze bracelets similar to the one found in Dombóvár (Q501) are very rare. Its *terminus post quem*, when the object got into the ground, is given by a Gratianus coin. Type 2: band bracelets with hook closing. The bracelets with V-shaped chased respectively embossed berry-form decorations like the one found in our cemetery are very rare (Q503, 56, Fig. 10, left), horizontal V-shaped and hering-bone-patterned bracelets are much more common in the middle and the second part of the 4th c. Type 3: open-ended wire bracelets with flattened or rounded and grooved ends or stylized snake heads. In 3 graves (Q39, 56, 1) 4 were found with coins from years between 330 and 361. The type with snake heads (Q1) may have been used for a longer period, its parallels are dated from the middle of the 4th c. to the first half of the 5th c.²⁸ Mostly, type 4 was unearthed (6), bracelets twisted from wire, with a hooked-looped clasp, with or without ringed fastening (Q39, 57, 498, 503), which were the most popular in the second third of the 4th c.²⁹; this is justified by the smoothed vessels

²⁷ BOON 1977, 200-201.

²⁸ KELEMEN 2008, 134.

²⁹ KELEMEN 2008, 136 parallels.

and the time of the minting of coins as well. Type 5 is a bronze bracelet decorated with dark blue beads. This version of bracelets made of wire is scarcer, mainly one per grave as found in 503 (*Fig. 17, right*). The type³⁰ used in the middle third of the 4th c. was found in our excavation together with coins of Constantinus I and Constantius II and three other bracelets.

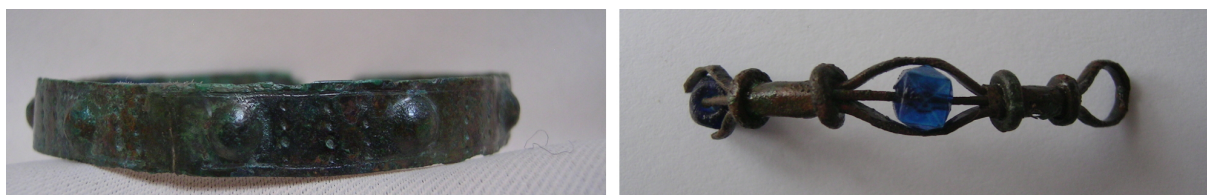

Fig. 17. Detail of a bracelet ornamented with embossing and chasing from grave 56 (left), and bracelet decorated with beads from grave 503 (right).

In 3 graves (Q498, 501, 503), 4 bone bracelets were unearthed, all of them from the type narrowed, bent on each other and fixed with small bronze nails. One of them is decorated with oblique grooving, the others are unadorned and have a chased horizontal line round the middle. The coins found with them suggest that they were used in the period between Constantius II and Gratianus.

As for the wearing customs, the left arm seems to have been preferred: out of 18 bracelets 11 were on the left and 7 on the right forearm. According to M. Kelemen, one of the reasons for this may have been that in the case of right-handedness the object was prone to damage. In two cases (Q57, 501) jewellery was only worn only on the left arm and in one case only on the right arm (Q1), otherwise on both arms. In 4 graves of women there was no bracelet (Q54, 84J1, 517, 522), in one case (Q464) the grave was disturbed so there might have been some jewellery.



Fig. 18 Finger ring with the remains of a glass-paste inlay (grave 522).

Finger rings were found in four graves (Q56, 503, 522, 1), all of them made of bronze. Finger rings with narrowed ends bent on each other (Facsády 2009, type VIII/c) were found in two graves: in grave 56 was one with hering-bone-like embellishment and 2 plain rings in the grave in Újdomobóvár. Similar pieces are common during the 4th c., the Dombóvár finger ring can be dated at the middle of the century on the basis of the age of the coins. The head of the signet ring with widening shoulder (Facsády 2009, type IV) in grave 503 is decorated with engraved lines. In the oval bezel of the finger ring in grave 522 (*Fig. 18*) there may have been a glass-paste inlay. The coins placed in the grave date both at the first part of the 4th c. In the 3 cases possible to be examined, the finger rings were worn on the left hand.

30 SWIFT 2000, 124 and 300.

Coins

Out of 23 graves in Dombóvár 12 i.e. about half of them contained coins, which is quite a high proportion.³¹ From the 109 coins the most (26) were in the disturbed grave of a woman (Q464). 21 coins were found in grave 40 (man), 17 coins from the grave of a girl buried with her jewels (Q56) and 13 coins from a child's grave, 41. Fewer were placed in the other graves, 1-9 coins (Q39, 54, 463, 498, 501, 502, 503, 522). Out of 7 man's graves only two contained coins, out of 8 woman's graves 5 and out of 6 child's graves 5. The coins were put first of all near the pelvis or at the knee near the shin-bone. The coins in grave (5, 13, 8 pieces) in graves 41, 56 and 502 must have been wrapped in some organic material: they were placed to the hands, standing closely behind each other in a line ('roll'). It is also worth mentioning that about 70 years passed between the dates of the minting of the coins found in grave 501. The coins minted at the beginning of the 4th c. are shiny almost in mint condition, however, the ones of the 70s of the century are much more worn.

Presumably the worn coins often used in everyday life were means of payment, while the high-quality, bigger coins were put in the grave for some other reason, they may have been jewellery or clothes ornaments.

The earliest coins were minted during the reigns of emperors Maximianus Herculius between 304-305 and Galerius Maximianus between 308-310, the latest during the reigns of emperors Valentinianus I, Valens and Gratianus 364-378. Most were minted during the Constantinian dynasty in the 350-360s. Most coins were made in the mint in Siscia, the other mints are only represented by some pieces (Thessalonica, Nicomedia, Aquileia, Sirmium, Cyzicus, Antiochia, Constantinopolis, Ticinum, Heracleia). Unfortunately in the case of about one third of the coins the place where the coins were minted cannot be stated because they are extremely worn.

Iron tools and objects

A 35-cm-long winged spear was placed beside the man buried in brick grave 84. The object was put on the edge of the grave, with its point towards the end of the grave – it may have been about 2 m together with the handle. The best parallel in form is known from grave I in Vajta³², which can be dated at a much earlier period, the 2nd-3rd c. and can be considered as a hunting weapon.³³ The graves that contained weapons and can be dated at the 4th c.³⁴, the spear points are smaller and besides them axes, knives, fibulae with bulb decoration, belt buckles and strap tips can be found. In the grave of the Dombóvár man there was an iron axe at the pelvis (perhaps it was hung on his belt), according to the type and its parallels³⁵ it was a tool used for woodwork. The shape of the robust knife found in the grave is dissimilar from the other knives in the cemetery, which may suggest a different function or usage. As the grave was disturbed at the area of the right shoulder – chest – left leg, it cannot be decided with complete certainty that the objects (considering a possibly missing fibula, sword, arrowhead)

31 TORBÁGYI 2009, table 1.

32 FÜLEP 1949, XXVIII.t.5.

33 MÁRTON 2002, 134; MRÁV 2006, 54-55.

34 MÁRTON 2002, 139-140; VARGA 2007, 39.

35 MÜLLER 1982, 107; RUPNIK 2014, 185-188 and Abb. 2.

were military or hunting accessories.³⁶ The plan of the grave different from the others (brick grave) refers to the superior status of the deceased, so do the dog placed on the skirt of the grave and the grave goods (silver belt buckle and strap tip, good-quality glass), and there may be connection with the nearby horse-dog burial (Q83). There are vague parallels with the iron accessories of the harness found beside the horse. It is not possible to trace any connection either with the bronze mounts and buckles of the horse burials of the 2nd-3rd c. or with the iron accessories of the harness in the horse grave in Nagykanizsa, which is closer in time³⁷. Bronze buckles similar to the triangular buckle ending in a rosette, unearthed in grave 83, have been found in man's graves (e.g.: Szentlászló-Szentegyedpuszta grave 3, Kisasszonyfa,³⁸ Nagykanizsa Roman cemetery I. 56. grave³⁹).

Iron knives were placed in 10 graves of the cemetery in Dombóvár (graves 39, 40, 58, 84, 463, 464, 502, 503, 507, 522). They can often be found equally in man's, woman's and child's graves, mainly the short-bladed versions (except for grave 84), near the shin-bone. In one case (Q58) the knife was uncovered at the upper part of the thigh-bone, it may have hung from the belt. In the latter man's grave a 10 cm-long pointed object square in cross section was put as well: maybe used to pierce in leather processing, it was put near the left shin-bone. It is a question what was the function of the small spindle-shaped iron object pointed at both ends, found in grave 522, on the right side of the child near the pelvis.

The typical object of the Late Roman graves in South-Pannonia is the iron rod pointed at one end, its function is disputed. As it belongs to the grave goods of woman's graves, researchers consider it as a means of some woman's job (weaving, spinning) and is determined as heddle rod, winder or spindle.⁴⁰ In Dombóvár such rods were found in 5 woman's and child's graves (Q39, 56, 57, 498, 503) near the shin-bone and in one case beside the head (Q56). Their lengths vary between 22 and 30 cm, they are round in cross section and solid. On the basis of the time when the coins were minted (between 331 and 361) and when the smoothed vessels were made, these graves can be dated at the middle third of the 4th c. not earlier.

The elongated iron object in graves 40 and 59 may have been a fire striker. The former was placed with a knife crosswise on the shin-bones, the latter may have been in a bag at the left shin-bone with a flint. Supposedly there was a bag in grave 518 as well near the right thigh, this is suggested by an iron ring fibula and a small bronze ring but no fire-lighting tools were found.⁴¹

Summary

On the basis of the examined grave furniture, it is likely that the cemetery at the Konda Stream was used as a burial site from the middle third of the 4th c. up to the end of the century. The Roman graves, too, excavated in Dombóvár – in Kölcsey utca, VII. utca, in the area of the brick factory along the road to Kapospula and the Public cemetery – during the 20th c., fit into this period (Fig.1.). When they are projected on a map, a line of roughly east-west direction is

36 More: BORUZS 2013.

37 EKE – HORVÁTH 2010, 166-169 and pictures 11-12.

38 DOMBAY 1957, Taf. XXIII/3, XL/2.

39 EKE – HORVÁTH 2010, 170 and picture 15.

40 Research history and technical problems recently: MÜLLER 2011; PÁSZTÓKAI-SZEÖKE 2012; MÜLLER 2016.

41 KELEMEN 2008, 106-109.

demarcated, which may have been a road as Roman cemeteries can be found along the roads leading out of the settlements. The part of the cemetery uncovered in 2007, lay to the north of this road along the road following the line of Perekaci-árok – supposedly running to the road to the fort in Alsóhetény in north-south direction. The main road crossing the valley of the Kapos runs in north direction towards the one-time Iovia, this is marked by the natural features and the graves of brick factory I, along the dirt road beside the present cemetery. The question what settlement (or settlements) the separate groups of graves of the cemetery belonged to is still unanswered. On the basis of the burial ritual, the character of the grave furniture, the geographical features and the network of settlements known so far it can be supposed that they may have been the burial sites of a village-like camp (*vicus*) or villa estates scattered among the roads. It can be assumed that there was Roman settlement in the triangle of the Kiskonda Stream, Perekaci-árok and the former brick factory I on the loess plateau but this was not confirmed by survey on the terrain.⁴² According to the data of *Itinerarium Antonini*, a travelogue written at the end of the 3th c., one of the stations, either *Pons Sociorum* or *Pons Mansuetiana* on the routes *Sopianae-Arrabona* and *Sopianae-Aquincum* was on the territory of the present Dombóvár.⁴³ Late Roman stray finds are known from the area near the Békátó⁴⁴ but it is not very likely that the settlement belonging to the burial site can be found on the other side of the Kapos as it is a marshland in this section of the river. Traces (brick and stone fragments) referring to a Roman settlement were observed on the Szőlőhegy and at the north-western edge of the town⁴⁵ as well, but it is uncertain which period they belonged to. Near Dombóvár, two find spots have to be mentioned, they can be dated at this period and may be connected with our find spots. On Mágocs-Szőlőhegy, to south-east, there may have been a villa estate and its cemetery, which is in the inner territory of the present town,⁴⁶ and the fort in Alsóhetény, some kilometres of the town, may come into consideration,⁴⁷ as it was a determining element of the area because of its size and its strategic importance. The fort was reconstructed – with much work – in the middle of the 370s, which means it was prepared for further use, i.e. probably in this period significant Roman settling can be reckoned in Dombóvár and its vicinity. On the other hand, the finds in the graves excavated in different parts of the town show that in the first half of the 5th c. there were no more burials there. No typical grave goods of the end of the century were found: half-egg-shaped glass, smoothed vessels, polyhedral earrings, bone combs, etc., that means that for some reason earlier population left the area.

References

ALBEKER, M. 1978: Késő rómaikori temető Dombóváron. *Archaeologiai Értesítő* 105, 66-77.

BARKÓCZI, L. 1988: *Pannonische Glasfunde in Ungarn*. *Studia Archaeologica* 9. Budapest.

42 See recently G. Szabó: Kapos - Hegyháti Natúrpark kulturális örökségi (régészeti) elemeinek katasztere. http://www.dombovar.hu/media/files/01._Naturparki_tanulmany_melleklete_Regeszeti_17.02.16.pdf (downloaded: 2018.04.13.)

43 TÓTH 2006, 113-114.

44 GAÁL 1980, 133.

45 CZÖVEK – ÓDOR 2009, 192-193: Sarok-dűlő 2, Delelői-tábla 2, Szilfás-dűlő 6.

46 GÁBOR 1998, 120.

47 TÓTH 2009.

- BARTUS, D. 2007: Női büszttel díszített csont hajtű a komáromi Klujber-gyűjteményből. In: BÍRÓ, Sz. (ed.) *Firkák I. Fiatal Római Koros Kutatók I. Konferenciakötete*. Győr, 191-196.
- BOON, G. 1977: Gold-in-Glass Beads from the Ancient World. *Britannia* 8, 193-207.
- BORUZS, K. 2013: Harcos vagy vadász? Római kori fegyveres sír a Konda patak partján. In: KRISTON VÍZI, J. (ed.): *Dél-Dunántúli Dolgozatok. Tanulmányok Dr. Szőke Sándor emlékére*. Helytörténeti Sorozat 12. Dombóvár, 20-30.
- BORUZS, K. 2016: A budaörsi temető üveg és üvegpasza mellékletei. In: OTTOMÁNYI, K. (ed.) *A budaörsi római vicus temetője*. Budapest, 373-395.
- BORUZS, K. – SZABÓ, G. 2009a: Dombóvár, Köztársaság utca (Kiskondai-patak, III. sz. téglagyár). In: KISFALUDI, J. (ed.) *Régészeti Kutatások Magyarországon*, 185-189.
- BORUZS, K. – SZABÓ, G. 2009b: Dombóvár, Köztársaság utca (Kiskondai-patak K-i oldala). In: KISFALUDI, J. (ed.) *Régészeti Kutatások Magyarországon*, 189-192.
- BORUZS, K. – SZABÓ, G. 2010: Dombóvár-Újdombóvár, Köztemető. In: KISFALUDI, J. (ed.) *Régészeti Kutatások Magyarországon*, 213-214.
- CZÖVEK, A – ÓDOR, J. G. 2009: Dombóvár határa. In: KISFALUDI, J. (ed.) *Régészeti Kutatások Magyarországon*, 192-193.
- DARÓCZI-SZABÓ, M. – BARTOSIEWICZ, L. 2017: Horse-dog burials from preventive excavations at Dombóvár TESCO. In: BORUZS, K. - BARTUS, D. (eds.): *FIRKÁK IV. Fiatal Római Koros Kutatók IV. Konferenciakötete. Dissertationes Archaeologicae Supplementum 1*. Budapest. 243-255.
- DÉVAI, K. 2012: *Késő római temetkezések üvegmellékletei Pannoniában. Üvegedények a mai Magyarország területéről*. Doktori disszertáció, ELTE-BTK. Budapest. Kézirat.
- DÉVAI, K. 2013: Glass vessels from Late Roman times found in the Hungarian part of Pannonia. *Dissertationes Archaeologicae Ser. 3. No. 1*, 259-274.
- DÉVAI, K. 2016: Glass vessels from Late Roman times found in Pannonia. *Acta Antiqua Academiae Scientiarum Hungariae* 67, 255-286.
- DOMBAY, J. 1957: Későrómai temetők Baranyában. *Janus Pannonius Múzeum Évkönyve* 2, 181-330.
- EKE, I. – HORVÁTH, L. 2010: Késő római temetők Nagykanizsán (Anyagközlés) *Zalai Múzeum* 19, 155-227.
- R. FACSÁDY, A. 2009: *Aquincumi ékszerek*. Az Aquincumi Múzeum Gyűjteménye 1. Budapest.
- FÜLEP, F. 1949: Rómaikori kocsitemetkezés Vajtán. *Archaeologiai Értesítő* 76, 40-51.
- GÁBOR, O. 1998: Későantik sírok Mágocson. *Janus Pannonius Múzeum Évkönyve* 43, 113-130.
- GAÁL, A. 1980: A Dombóvár-békatói XVI-XVII. századi temető. *Wosinsky Mór Múzeum Évkönyve* 8-9, 133-233.
- HORVÁTH, FR. 2016: Eine Besondere Gruppe der Spätromischen Keramik mit Polierter Oberfläche. *Antaeus* 34, 41-104.
- H. KELEMEN, M. 2008: *Solva. Esztergom későrómai temetői*. Libelli Archaeologici Ser. Nov. No. 3. Budapest.
- KELLER, E. 1971: *Die spätromischen Grabfunde in Südbayern*. Münchner Beiträge zur Vor- und Frühgeschichte 14. München.

- MÁRTON, A. 2002: Roman burial with a weapon from the Bécsi road cemetery (Aquincum-Budapest). *Communicationes Archaeologicae Hungariae*, 117-152.
- MERCZI, M. 2016: A Budaörs-Kamaraerdei-dűlőben feltárt római temető fibulái. In: OTTOMÁNYI, K. (ed.) *A budaörsi római vicus temetője*. Budapest, 432-489.
- MRÁV, Zs. 2006: Paradeschild, Ringknaufschwert und Lanzen aus einem römerzeitlichen Wagengrab in Budaörs. Die Waffengräber der lokalen Elite in Pannonien. *Archaeologiai Értesítő* 131, 33-73.
- MÜLLER, R. 1982: *A mezőgazdasági vaseszközök fejlődése Magyarországon a késővaskortól a török kor végéig*. Zalai Gyűjtemény 19. Zalaegerszeg.
- MÜLLER, R. 2011: Spinnrocken aus Metall und Spinnwirtel im Spätkaiserzeitlichen Pannonien. *Acta Archaeologica Academiae Scientiarum Hungariae* 62, 175-198.
- MÜLLER, R. 2016: Radius oder Colus? Textilhandwerk und Umweltveränderung im spätkaiserzeitlichen Pannonien. *Acta Archaeologica Academiae Scientiarum Hungariae* 67, 449-468.
- OTTOMÁNYI, K. 2007: A pátyi római telep újabb kutatási eredményei. *Studia Comitatus* 30, 7-238.
- OTTOMÁNYI, K. 2011: Késő római mázas kerámia a budaörsi telepen. *Arrabona* 49/1, 263-290.
- PÁSZTÓKAI-SZEÖKE, J. 2012: Vasból készült szövőeszközök és textilművesség a 4. századi Dunántúlon. (Iron weaving tools and textile production in Transdanubia during the fourth century AD.) In: PETKES, Zs. (ed.): *Hadak Útján XX. Népvándorlaskor Fiala Kutatóinak XX. Összejövetelének konferenciakötete. Budapest-Szigethalom 2010. október 28-30*. Budapest, 15-26.
- PÉTERFI, Zs. 1993: A Bátaszék-Kövesd pusztai későrómai temető. *Wosinsky Mór Múzeum Évkönyve* 18, 47-128.
- PRÖTTEL, Ph. M. 1991: Zur Chronologie der Zwiebelknopffibeln. *Jahrbuch des Römisch-Germanischen Zentralmuseums* 35.1, 347-372.
- RIHA, E. 1979: *Die römischen Fibeln aus Augst und Kaiseraugst*. Forschungen in Augst 3. Augst.
- RUPNIK, L. 2014: Secures, asciae und dolabrae aus Keszthely-Fenekpuszta. In: HEINRICH-TAMÁSKA, O. – STRAUB, P. (eds.) *Mensch, Siedlung und Landschaft im Wechsel der Jahrtausende am Balaton*. Castellum Pannonicum Pelsonense 4. Budapest-Keszthely, 181-204.
- SWIFT, E. 2000: *Regionality in dress accessories in the Late Roman West*. Monographies Instrumentum 11. Montagnac.
- SZABÓ, G. 2007: *Föld felett, föld alatt*. Dombóvár.
- SZABÓ, G. 2010: A dombóvári régészeti kutatások és a környék története az őskorban. In: DR. PAPP N. (ed.): *Városunk Dombóvár a kezdetektől napjainkig*. Dombóvár, 52-79.
- SZŐKE, S. 1996: Dombóvár földrajzi környezete és története. In: SZŐKE, S. (ed.): *Dombóvár*. Dombóvár, 25-178.
- TORBÁGYI, M. 2009: „Purse finds” in the Late Roman Graves in Pannonia. In: BÍRÓ, Sz. (ed.): *Ex officina... Studia in honorem Dénes Gabler*. Győr, 525-536.
- TÓTH, E. 2006: *Itineraria Pannonica. Római utak a Dunántúlon*. Budapest.
- TÓTH, E. 2009: *Studia Valeriana. Az alsóhetényi és ságvári késő római erődök kutatásának eredményei*. Helytörténeti Sorozat 8. Dombóvár.
- VARGA, K. 2007: Előzetes beszámoló a Ménfőcsanak-Eperföldek lelőhelyen feltárt késő római temetőről. In: BÍRÓ, Sz. (ed.) *Firkák I. Fiala Római Koros Kutatók I. Konferenciakötete*. Győr, 35-49.
- WOSINSKY, M. 1896: *Tolna vármegye az őskortól a honfoglalásig. I-II*. Budapest.

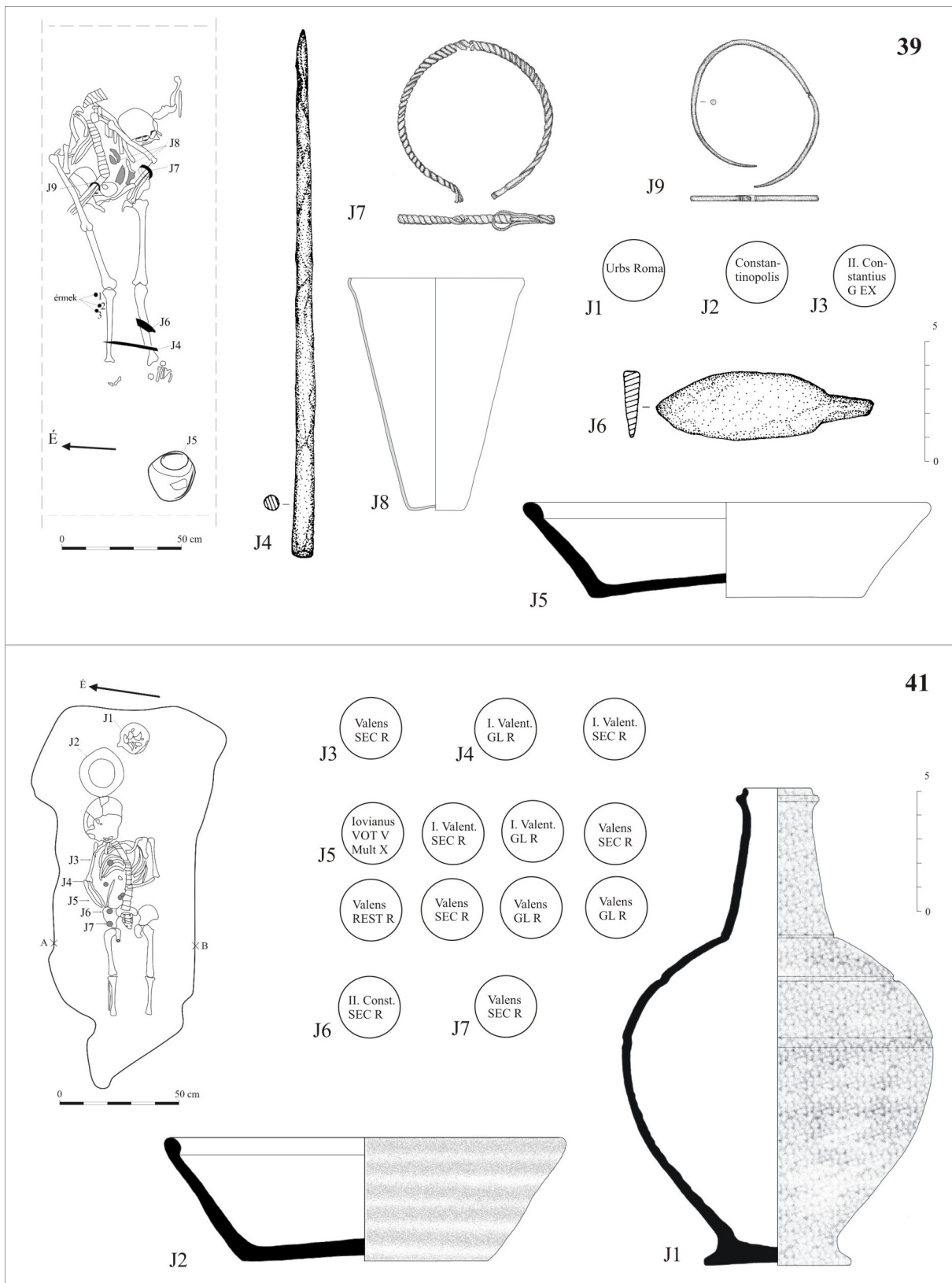

Plate I.

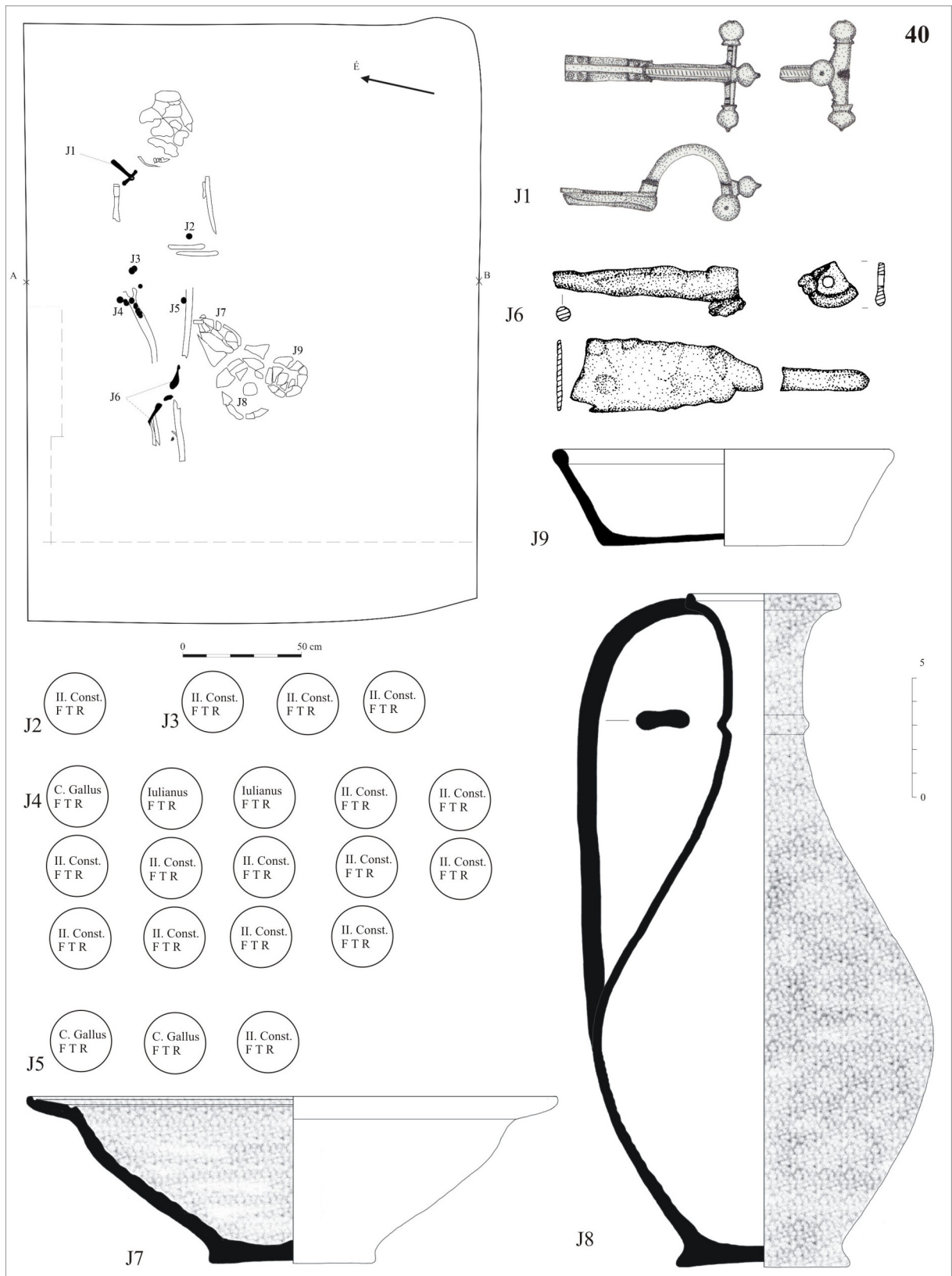

Plate II.

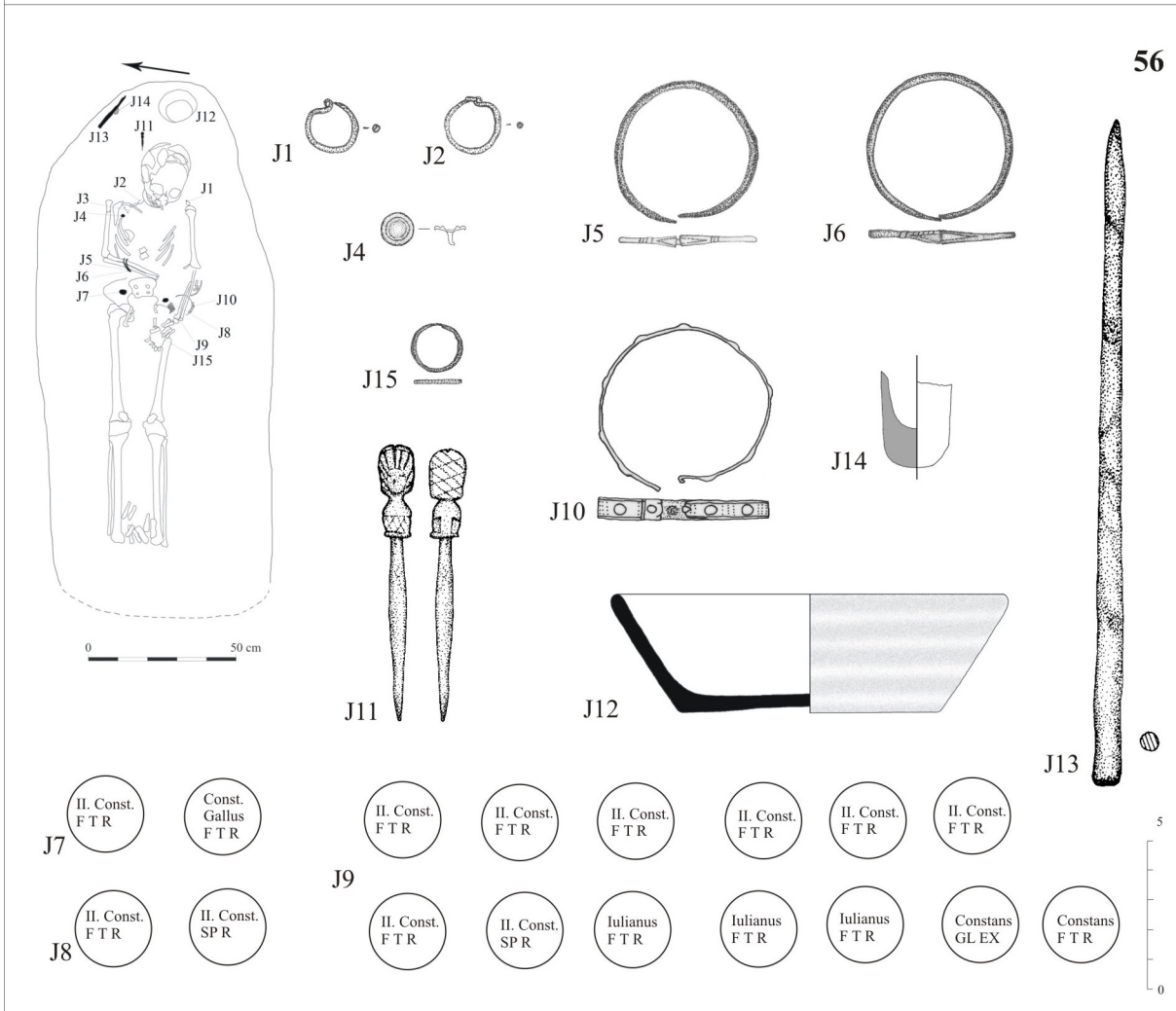
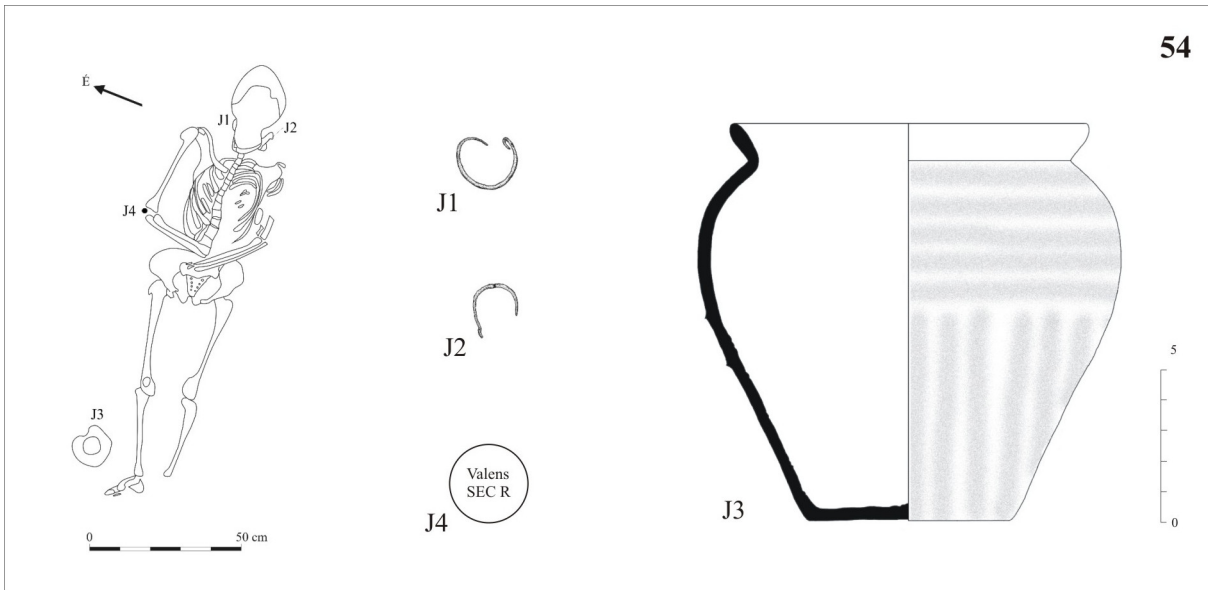

Plate III.

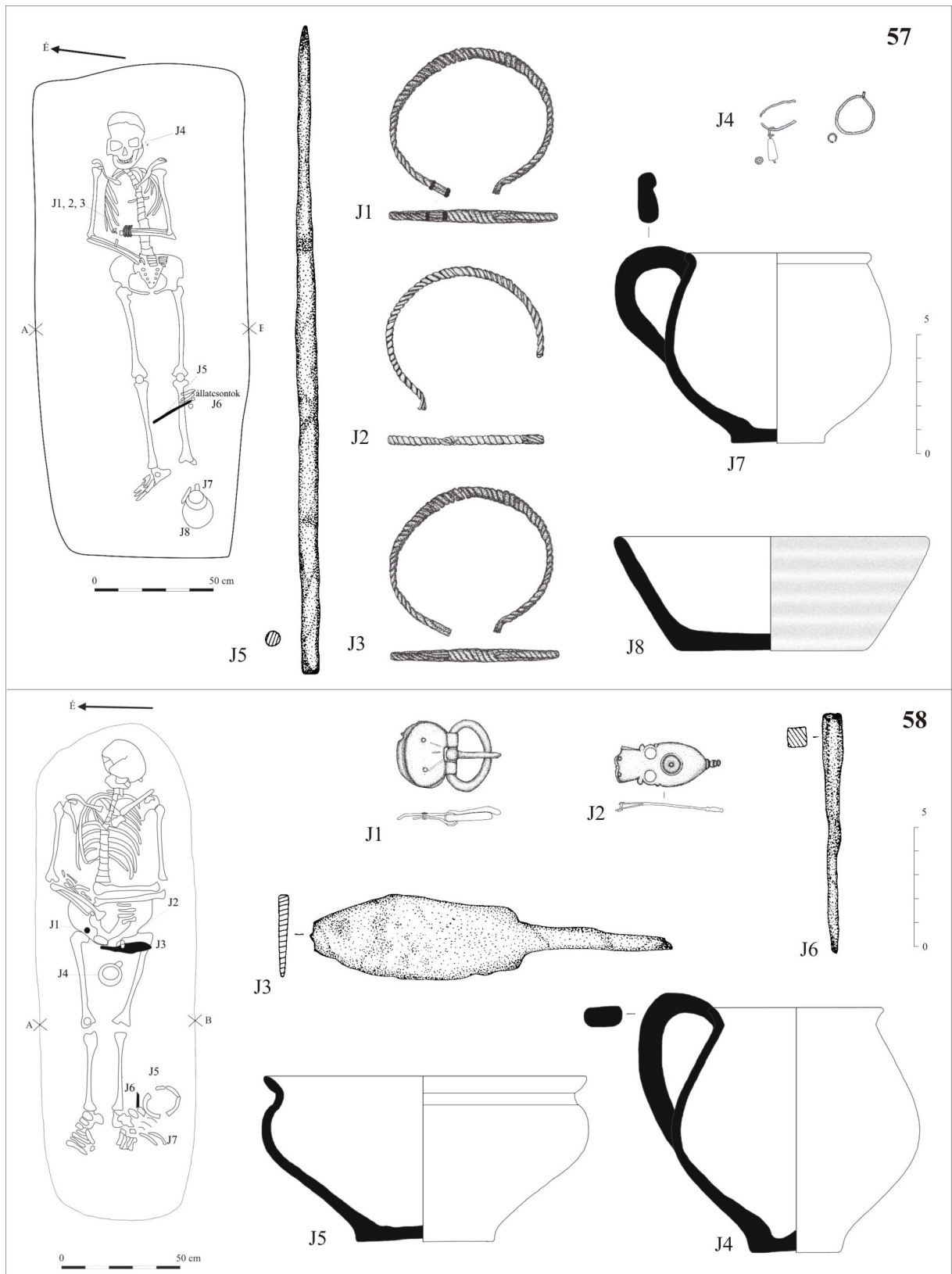

Plate IV.

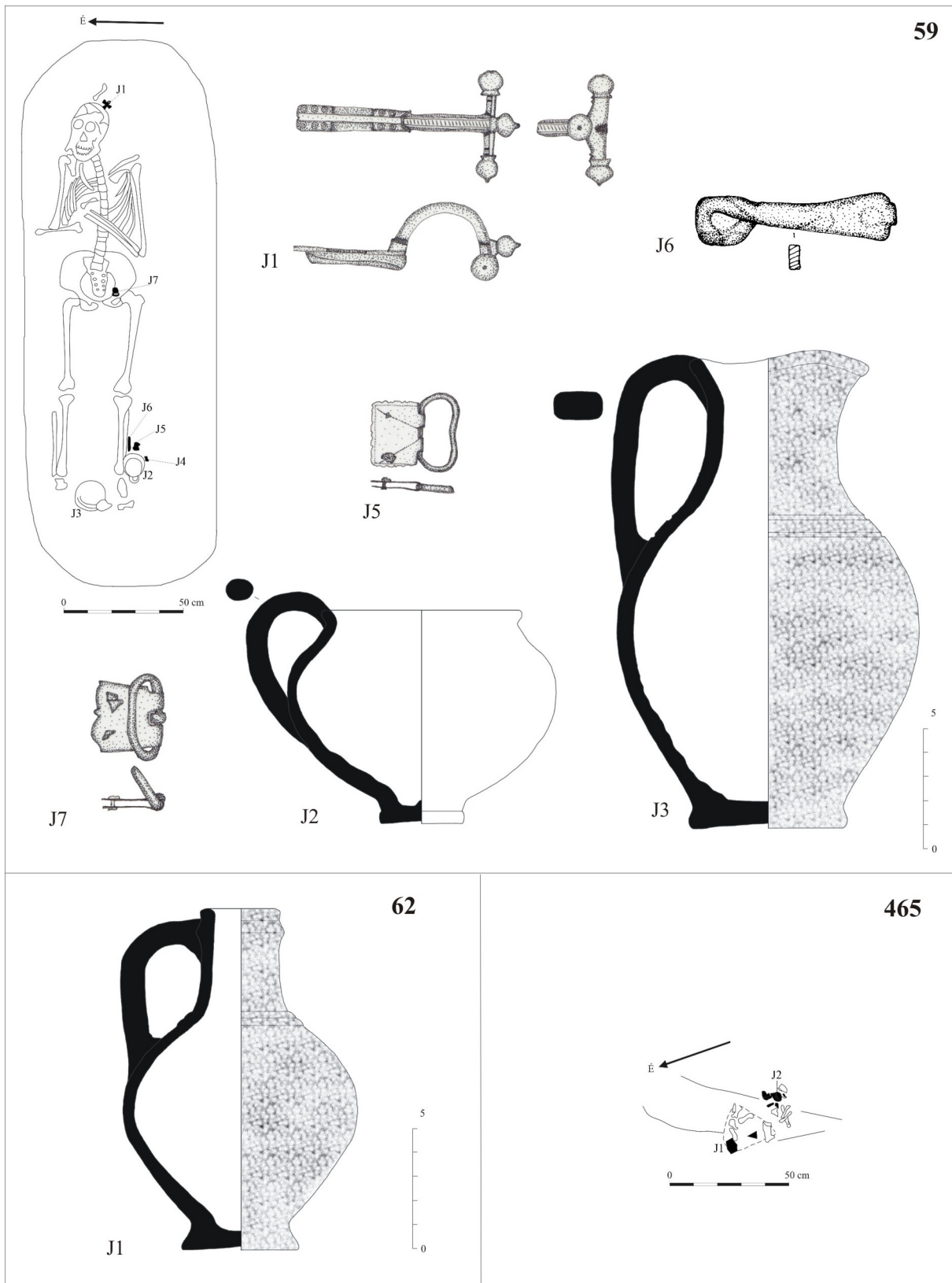

Plate V.

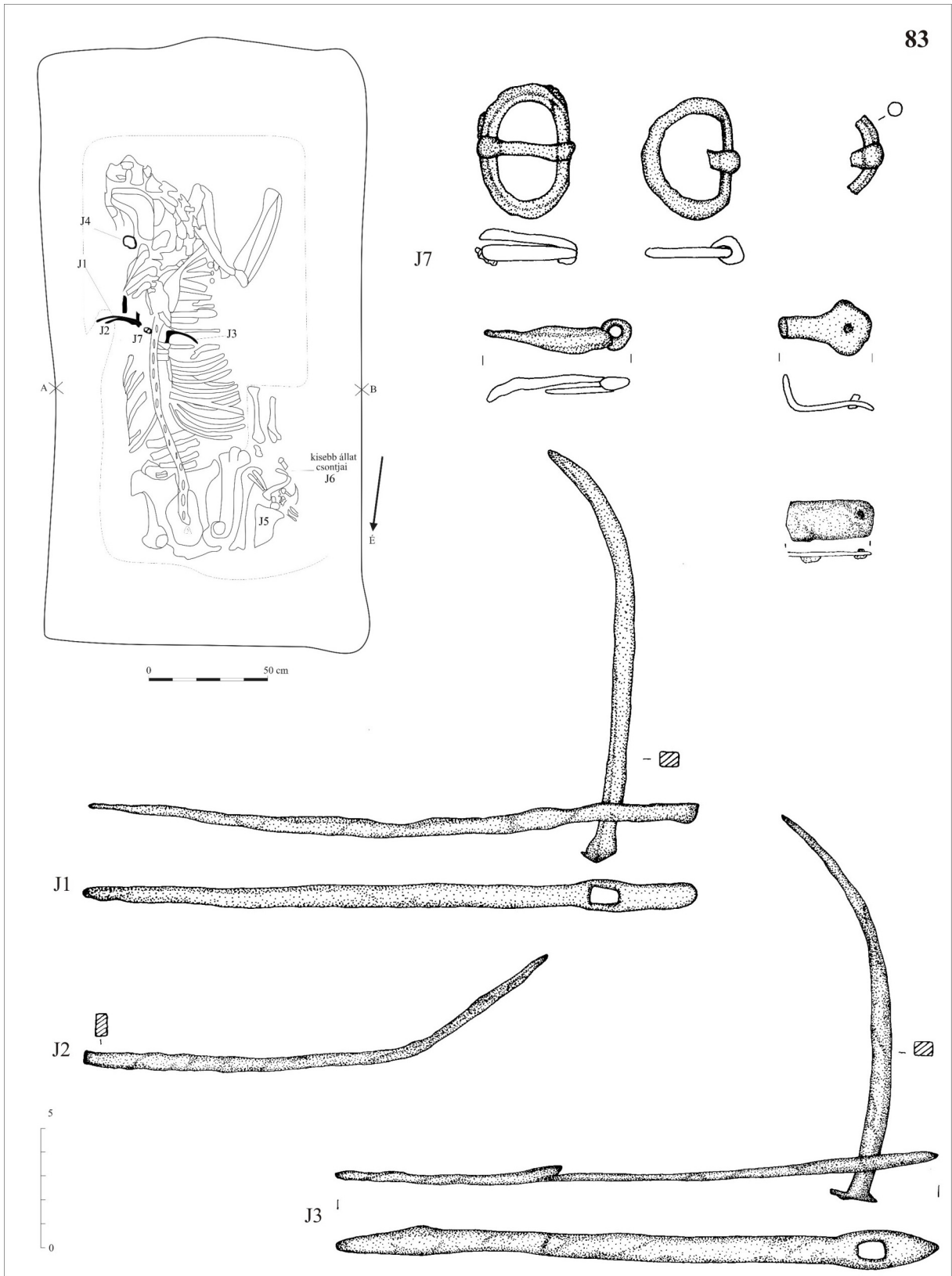

Plate VI.

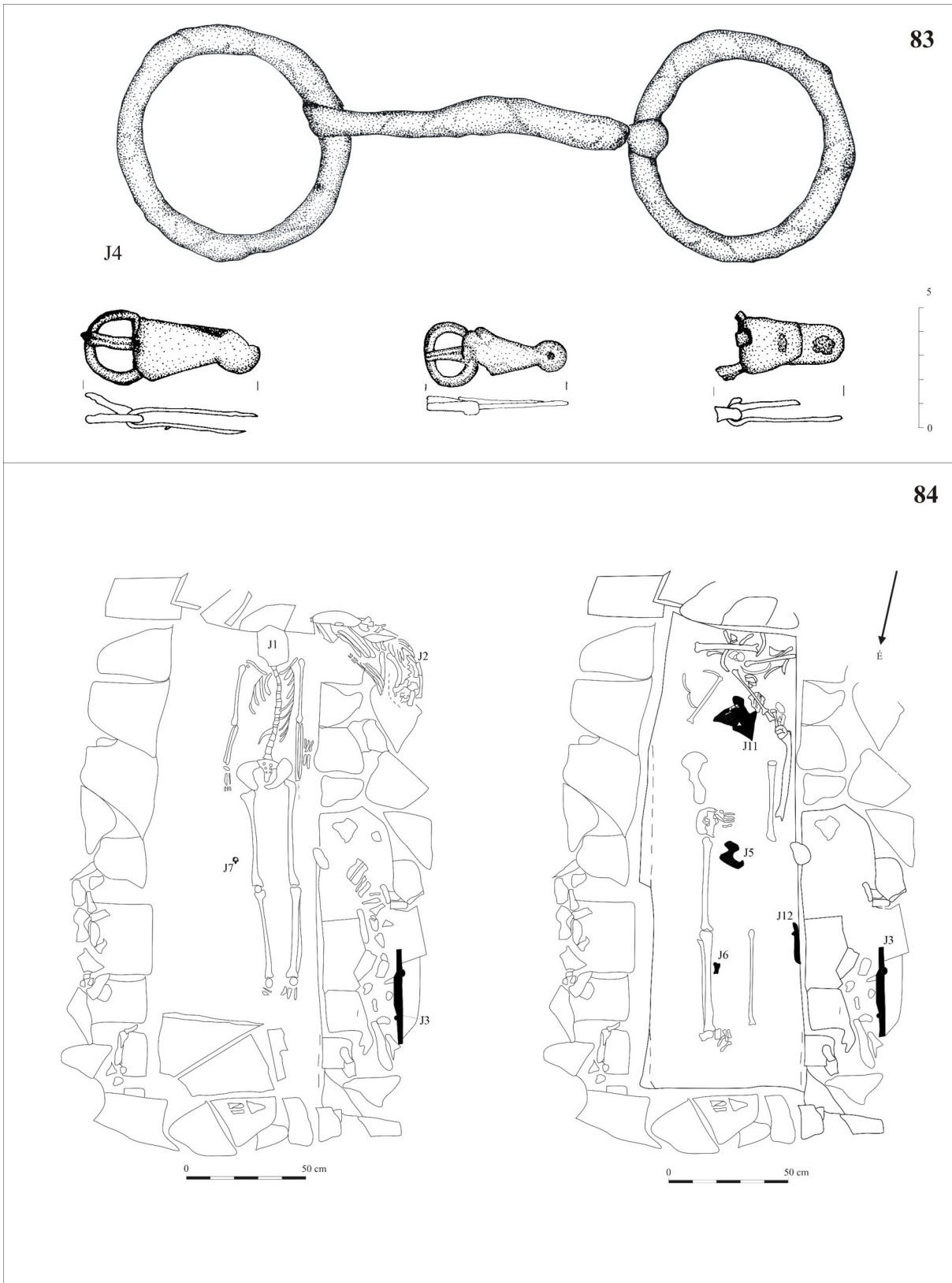

Plate VII.

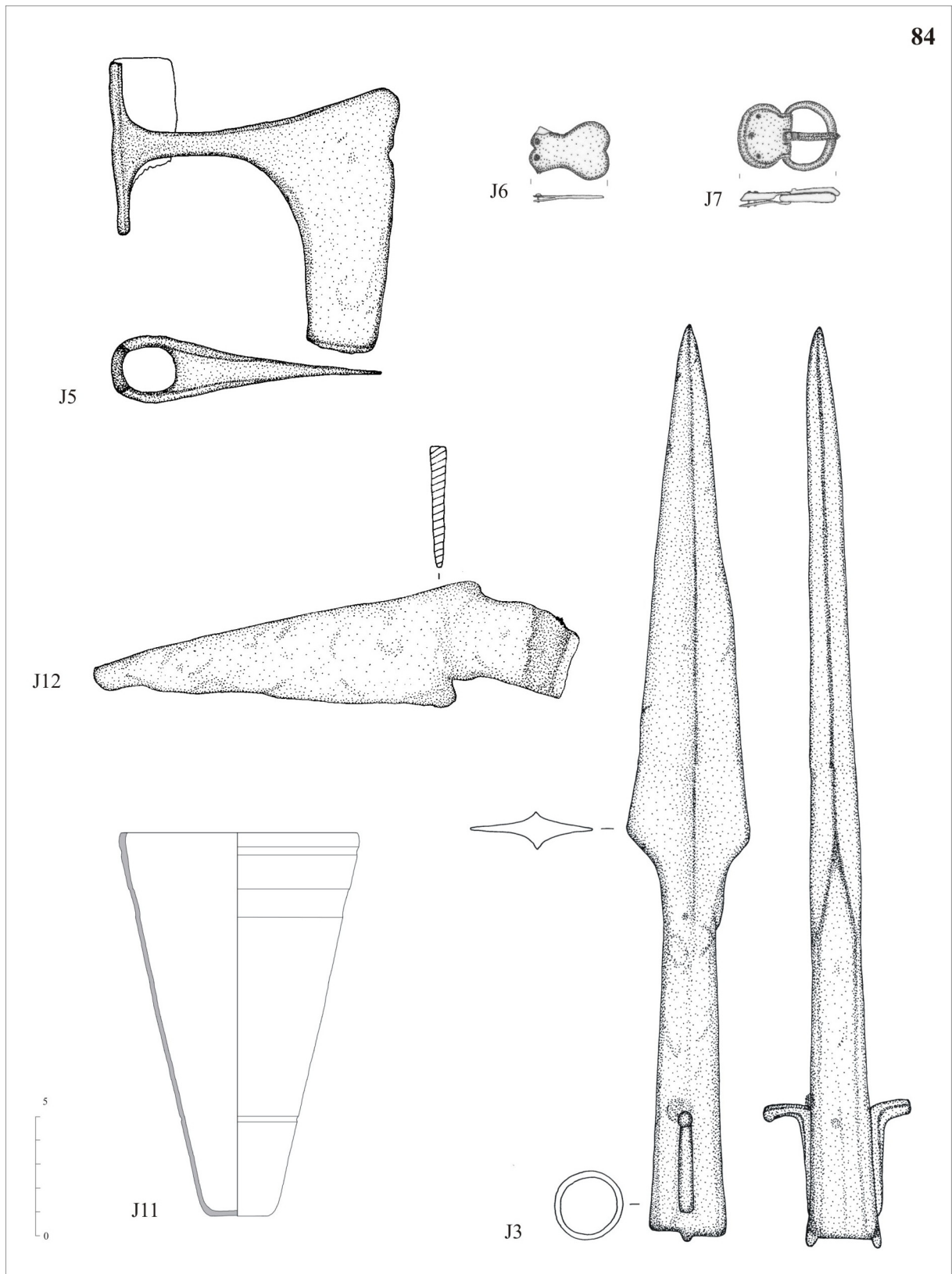

Plate VIII.

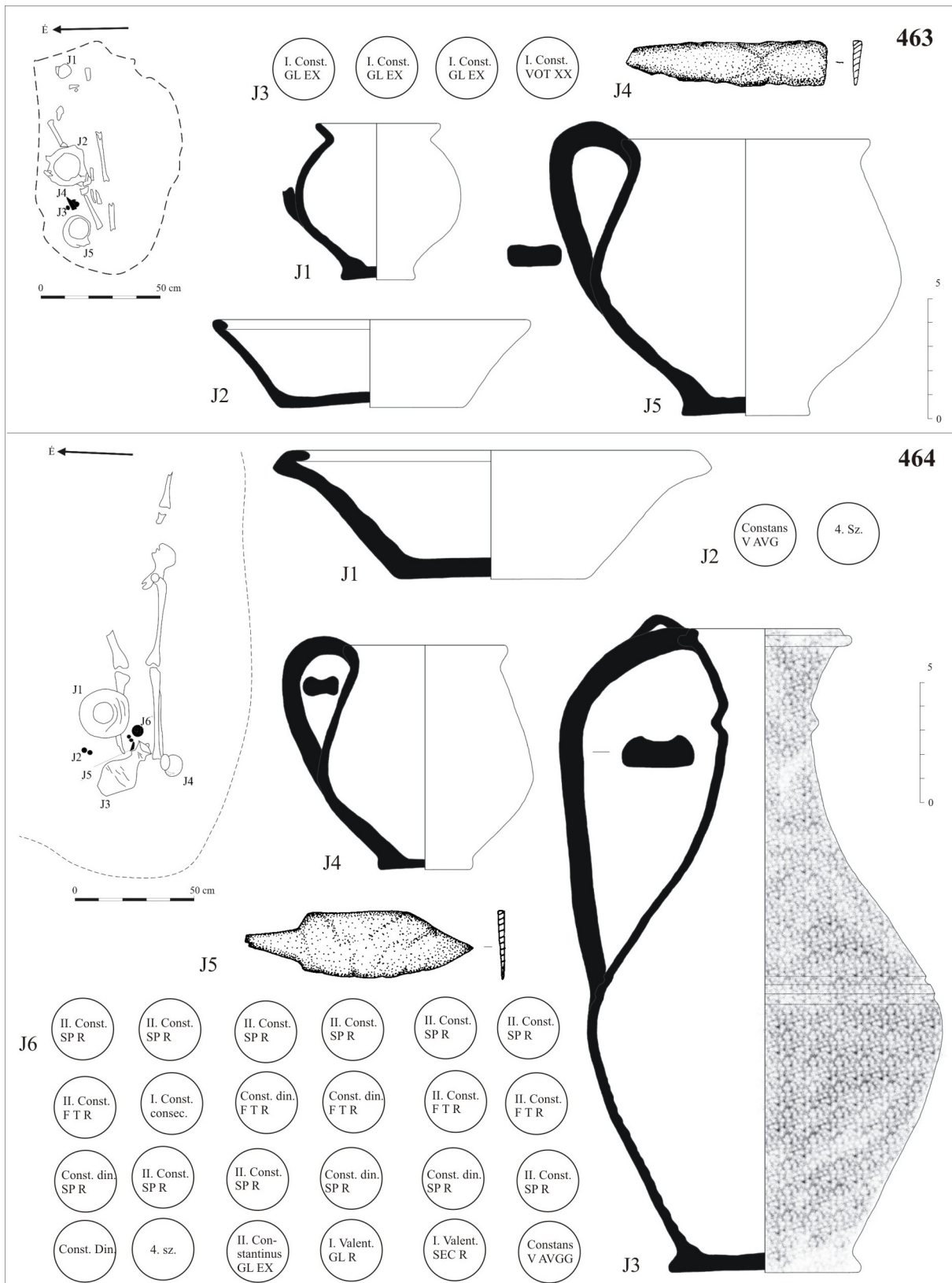

Plate IX.

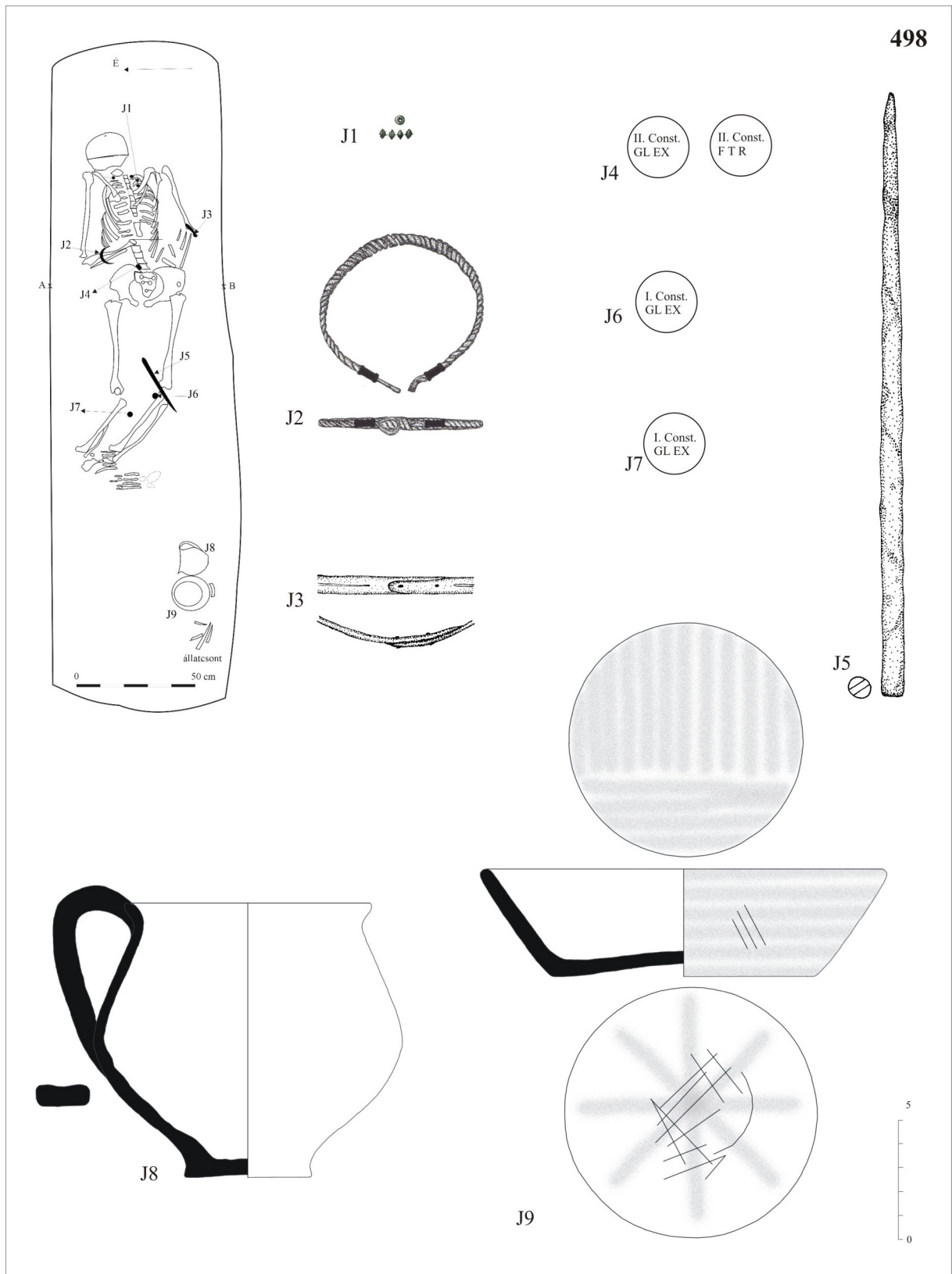

Plate X.

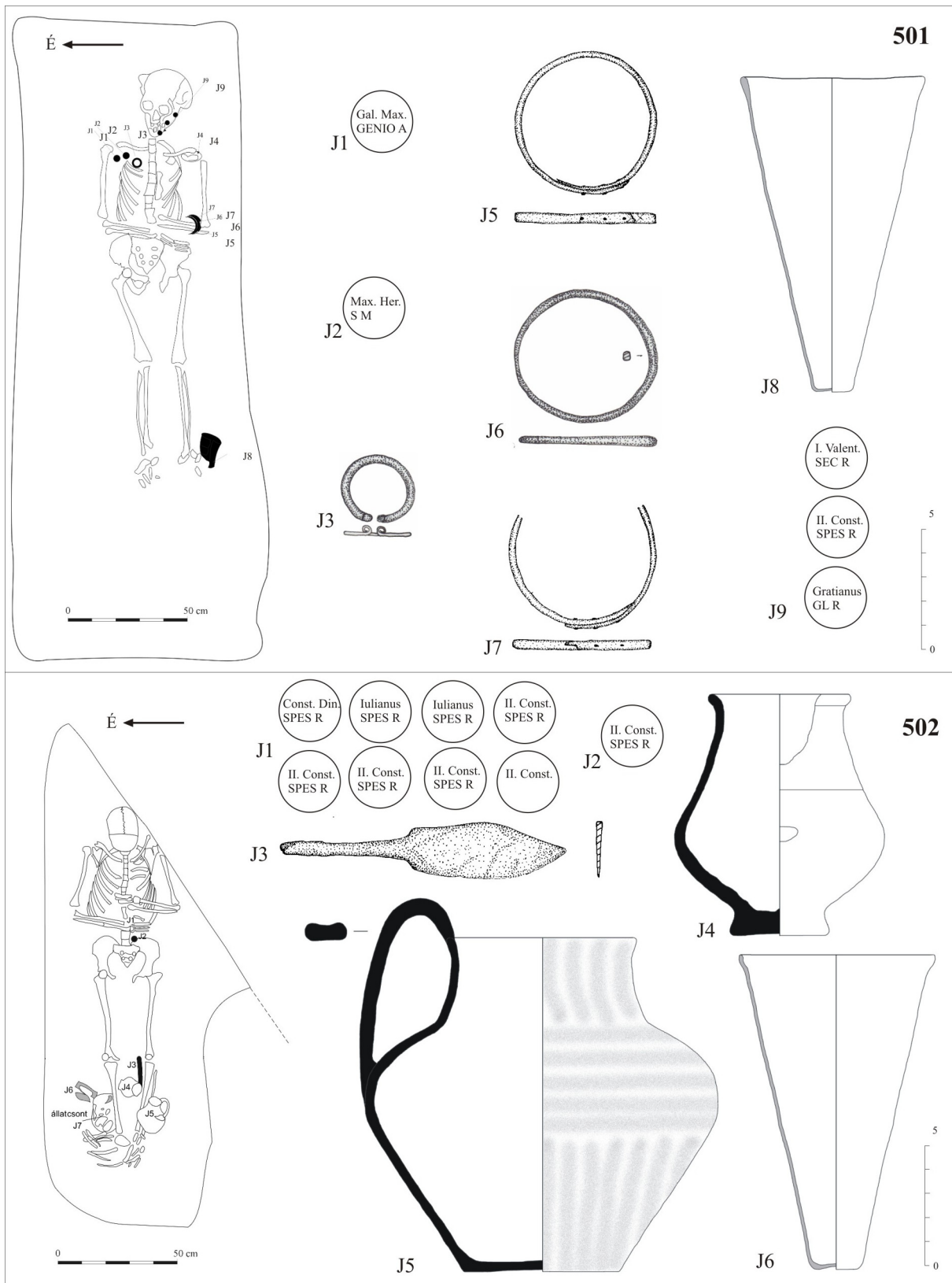

Plate XI.

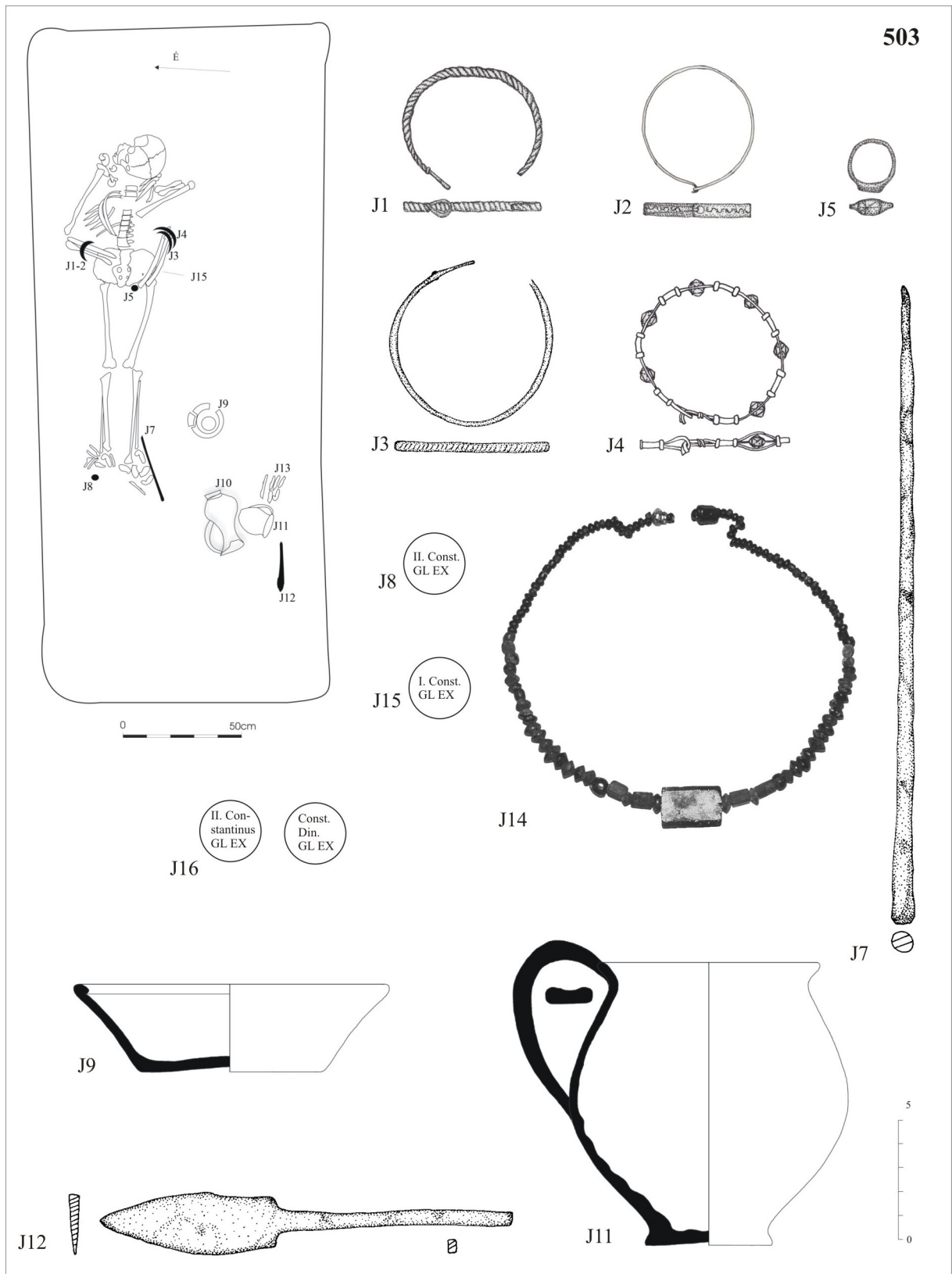

Plate XII.

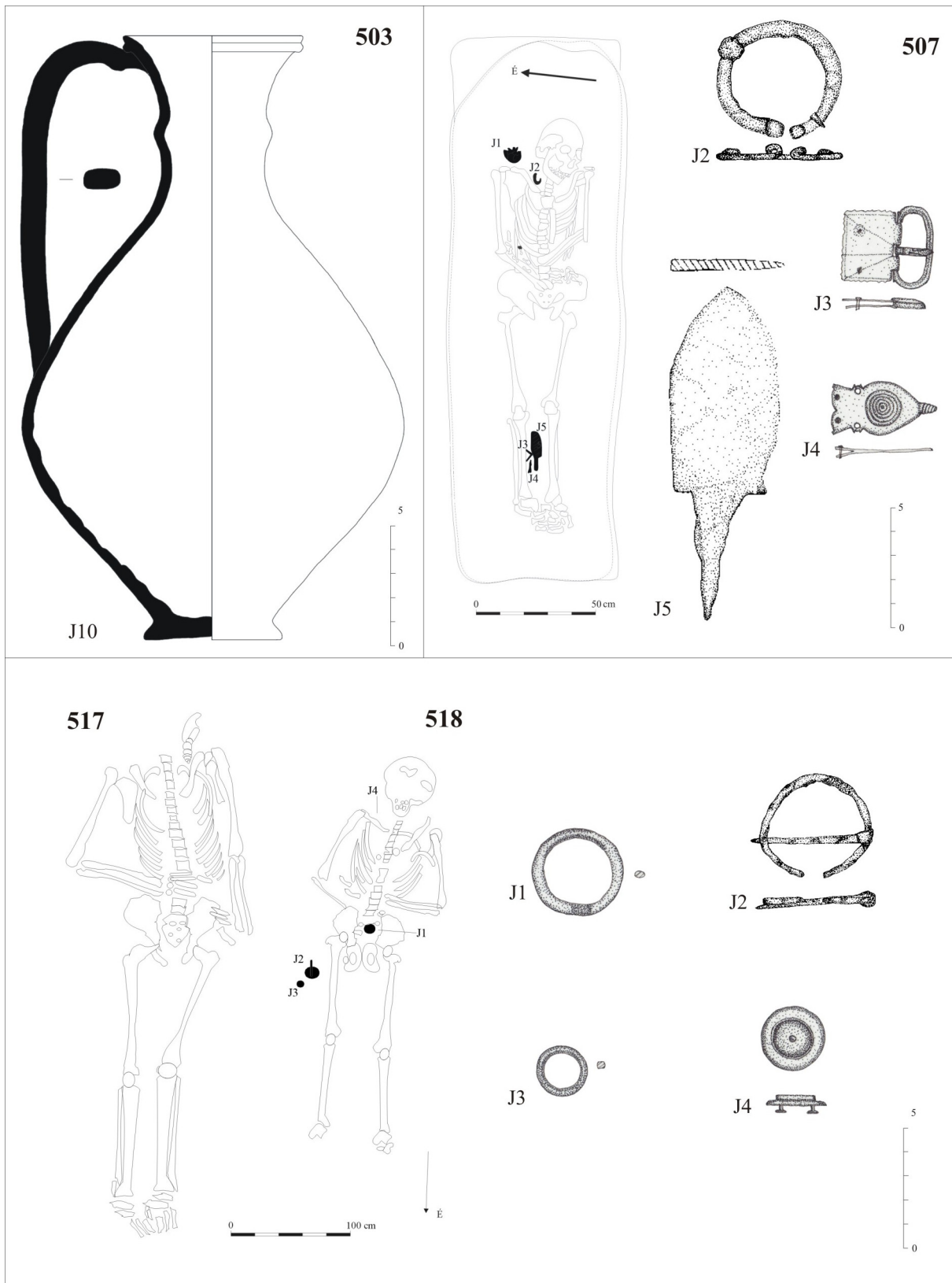

Plate XIII.

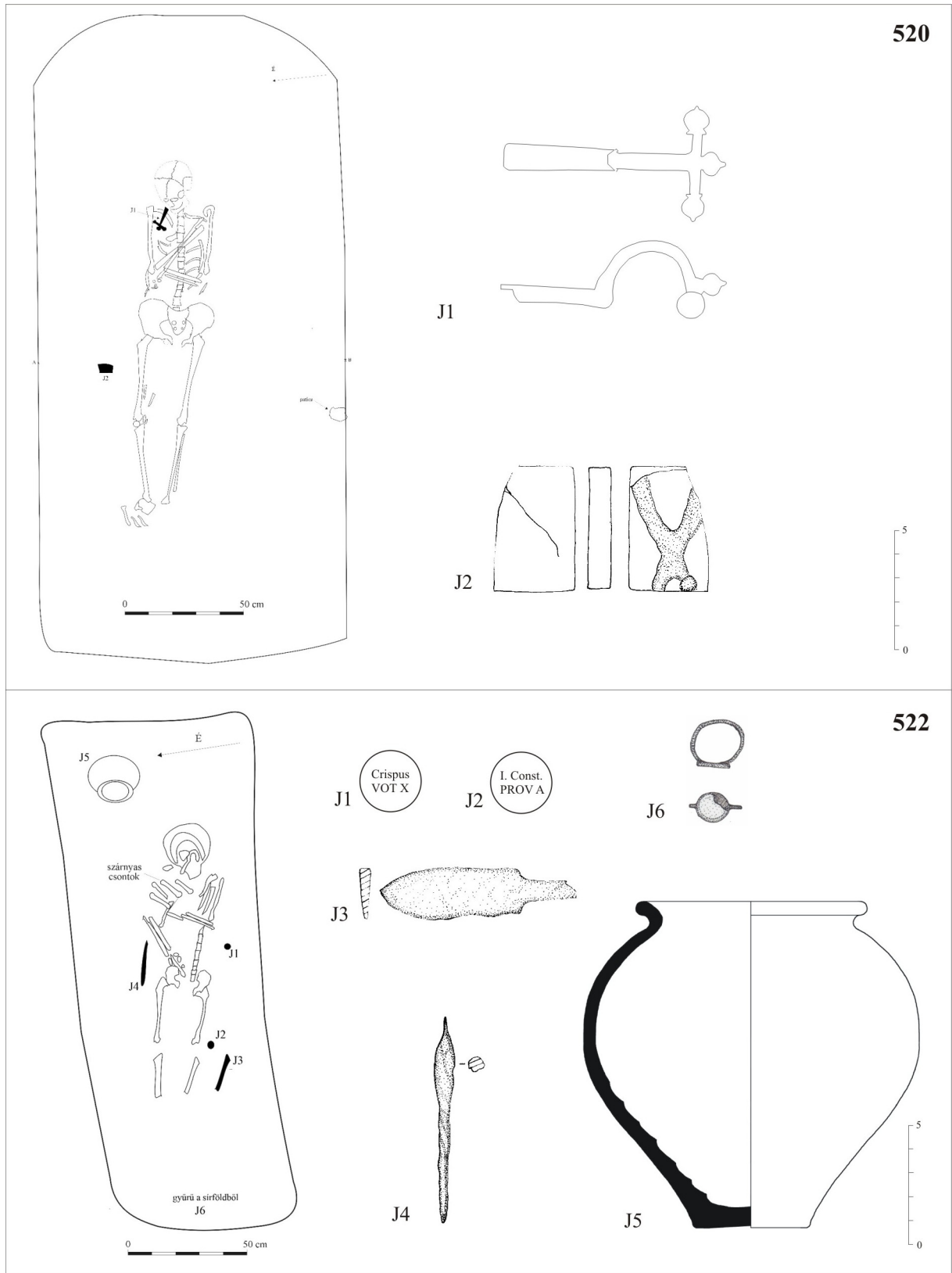

Plate XIV.

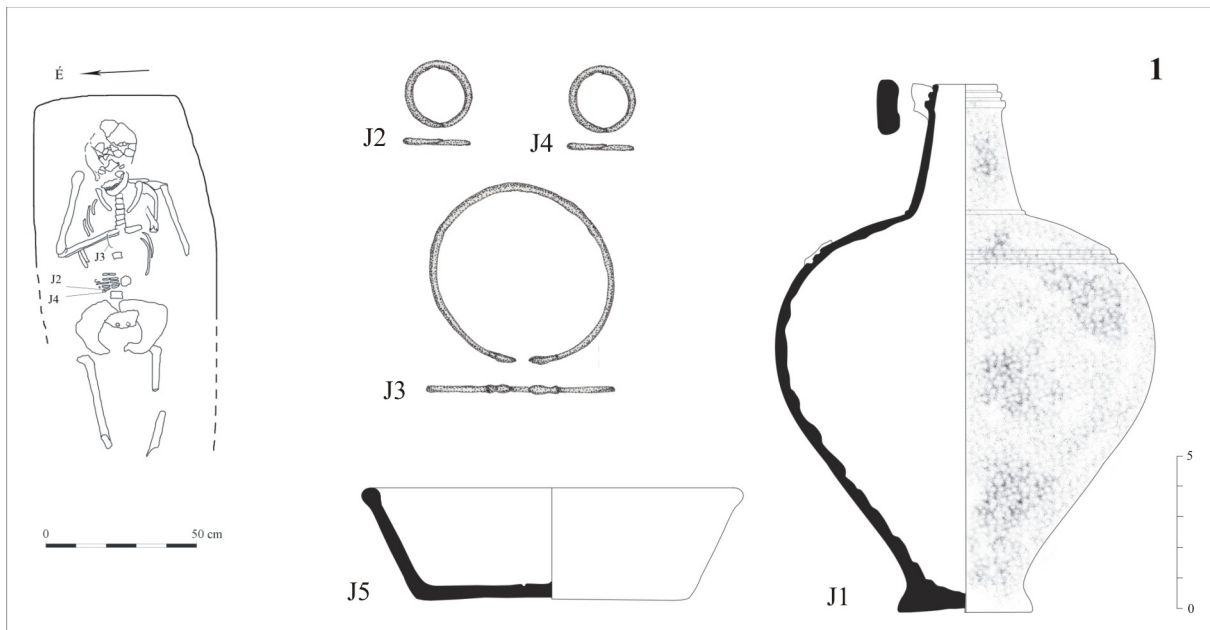

Plate XV.